

NRG Offas Dyke NG215S

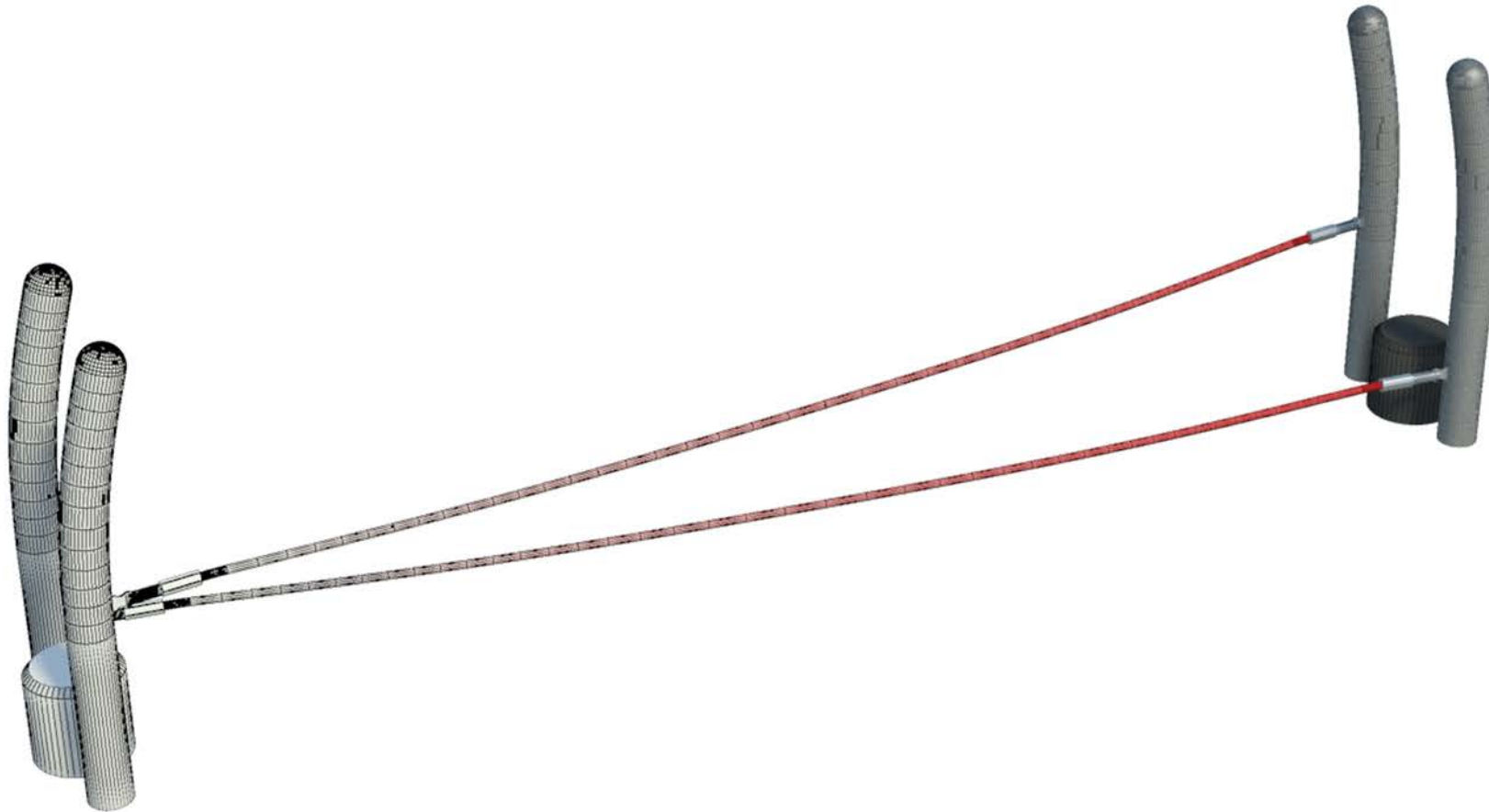

1 **23 kg!** **78803026**
2 No
Cape Horn Post (Type A)

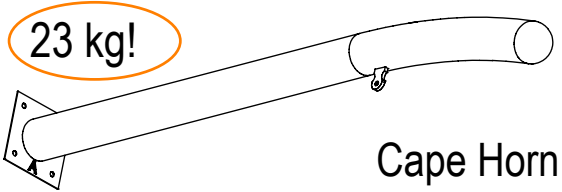

2 **23 kg!** **78803027**
2 No
Cape Horn Post (Type C)

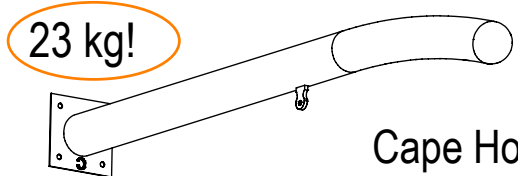

3 **78805028**
2 No
3807mm Long Foot Rope

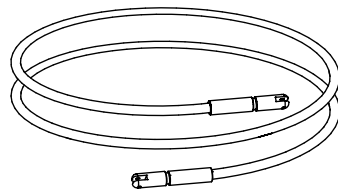

4 **RYBL300**
2 No
300mm Black Bollard

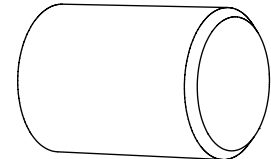

5 **803703**
2 No
300mm Bollard Fix Post

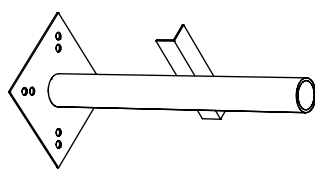

6 **RYADHBK**
1 No
Bollard Adhesive
<http://www.alansonsuk.com/downloads.asp>



7 **950040**
1 No
High Strength Thread Lock

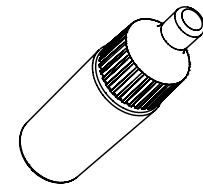

GB - Verify ropes fit – remove before concreting
ES – Utilizar las cuerdas para verificar la distancia entre los postes - quitarlas antes de poner el hormigón
FR – Utiliser les cordes pour vérifier la distance entre les poteaux - les retirer avant bétonnage
DE – Überprüfen Sie, dass die Seile passen - vor der Betonierung
IT – Usare le corde come distanziali – rimuoverle prima di cementare i pali
SE – Kontrollera att de linorna passa - flyttas innan betongarbete

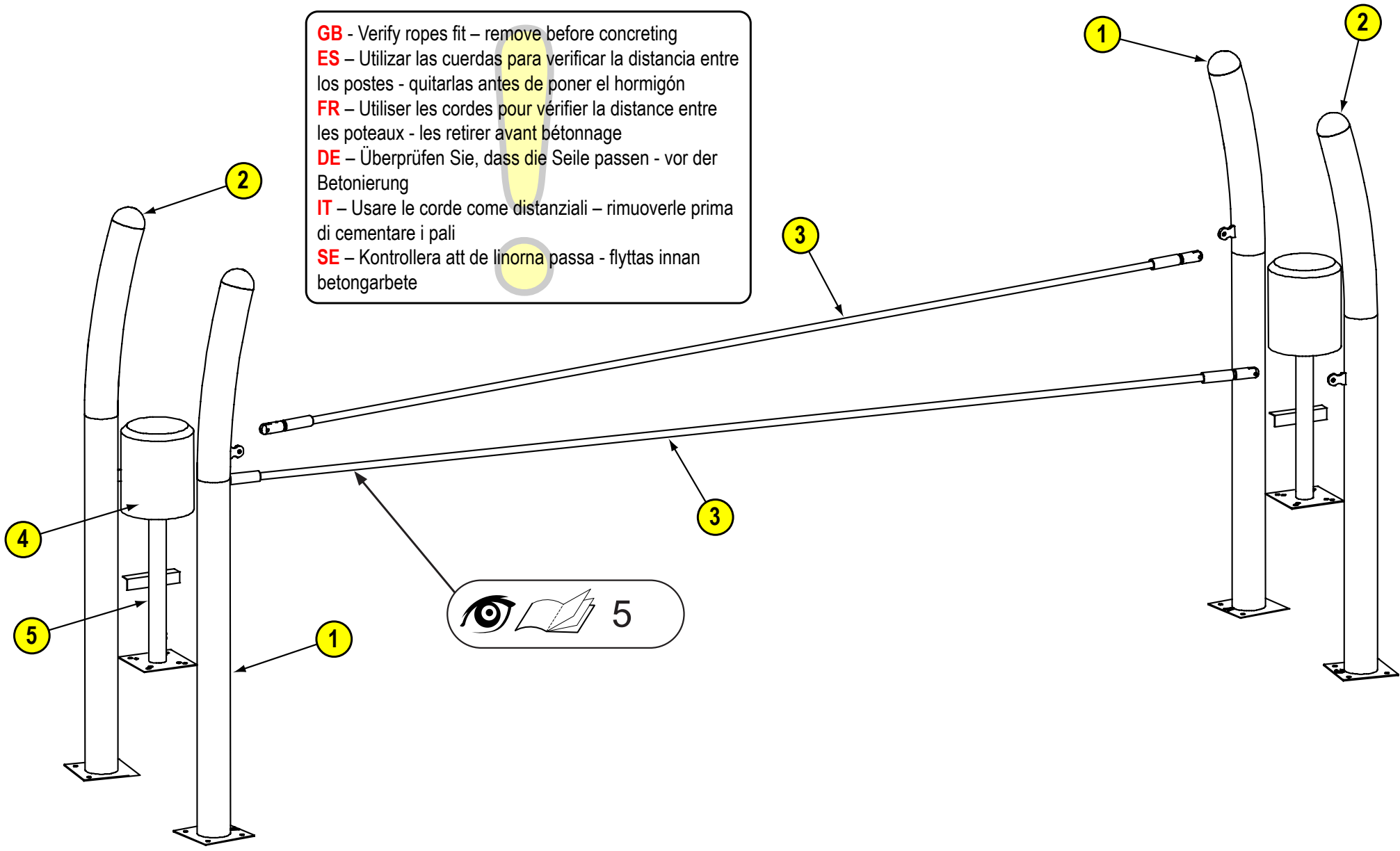

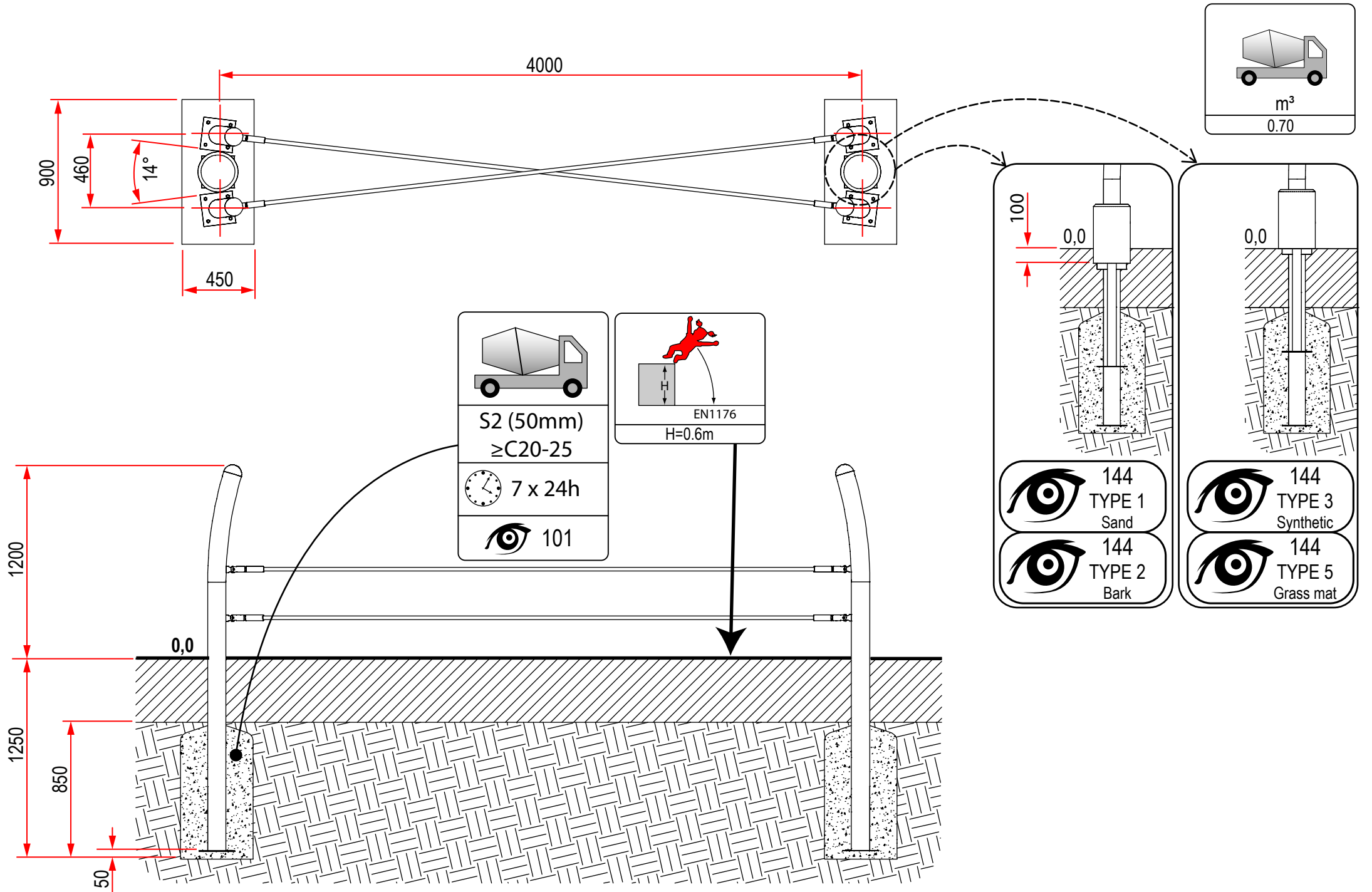

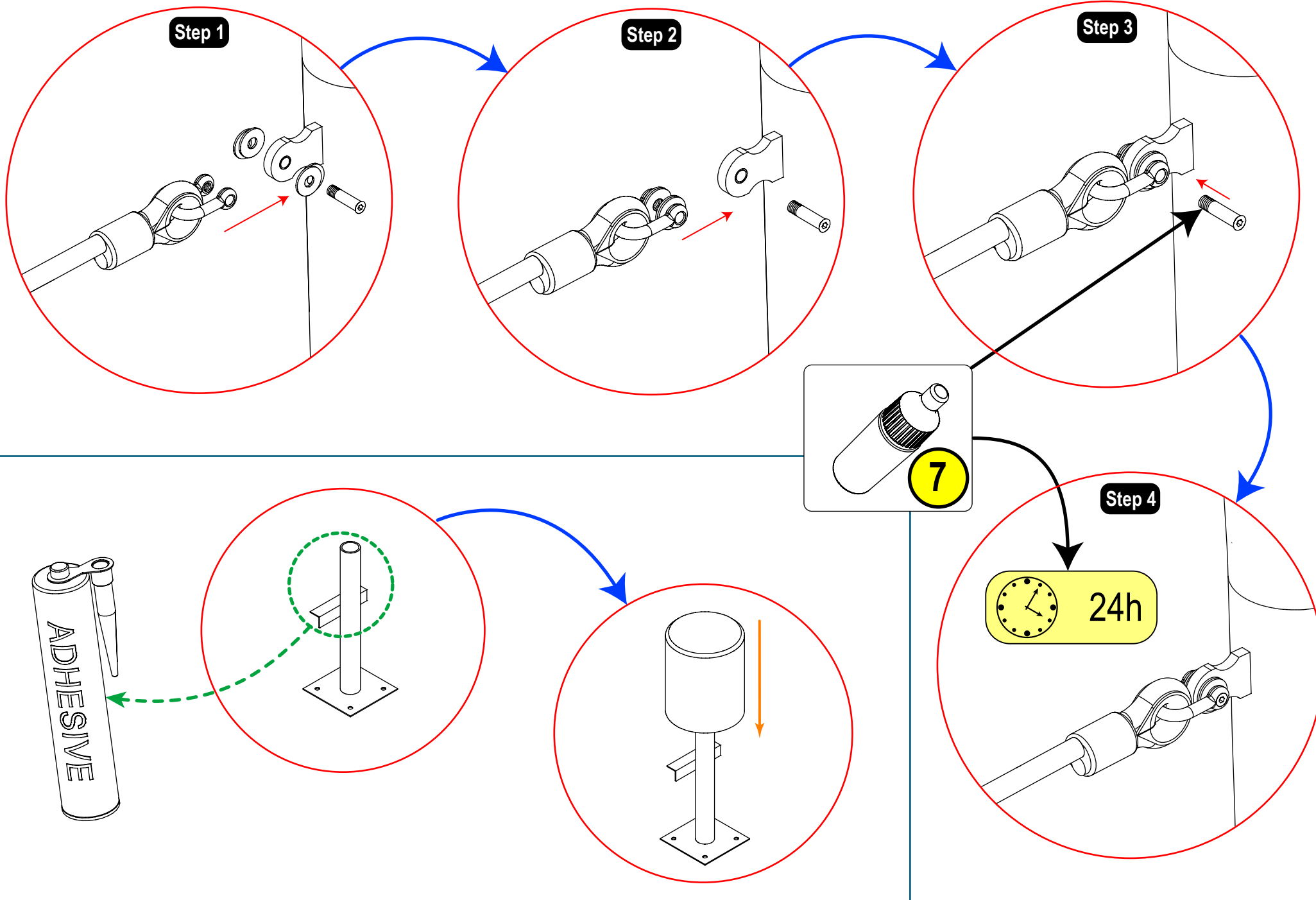

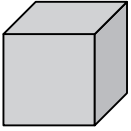

LxWxH (m)
4.25 x 0.58 x 1.20

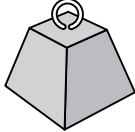

kg
142

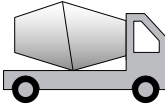

m³
0.70

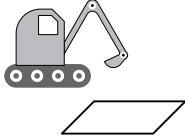

m²
10 x 10



X 2 = T
T = 8 hr

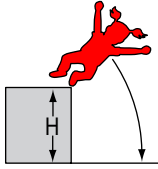

EN1176
H=0.60m

