

TYPE	HAGS.NO
 45°	8009974
 (3x)	8022217

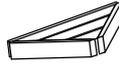
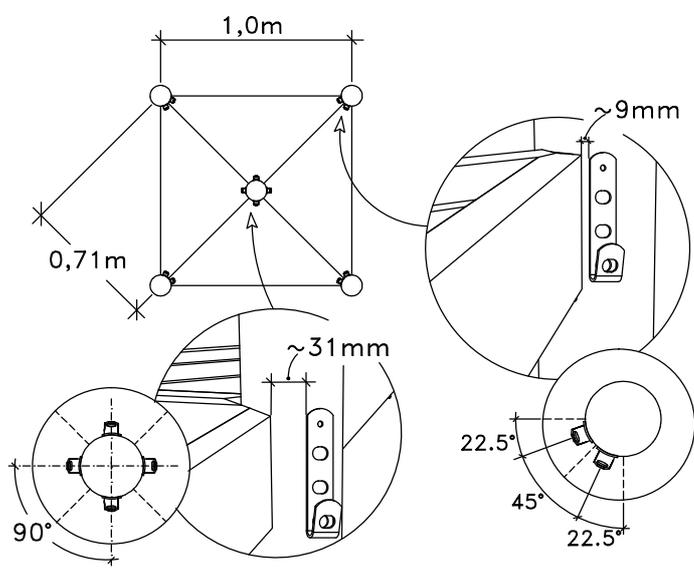
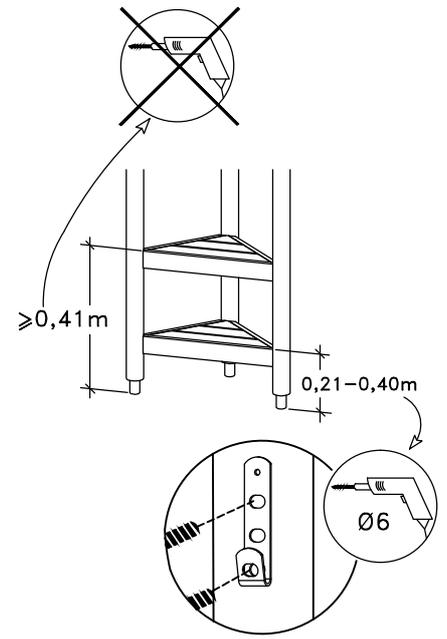
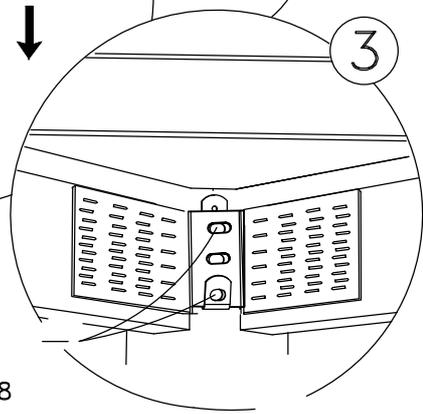
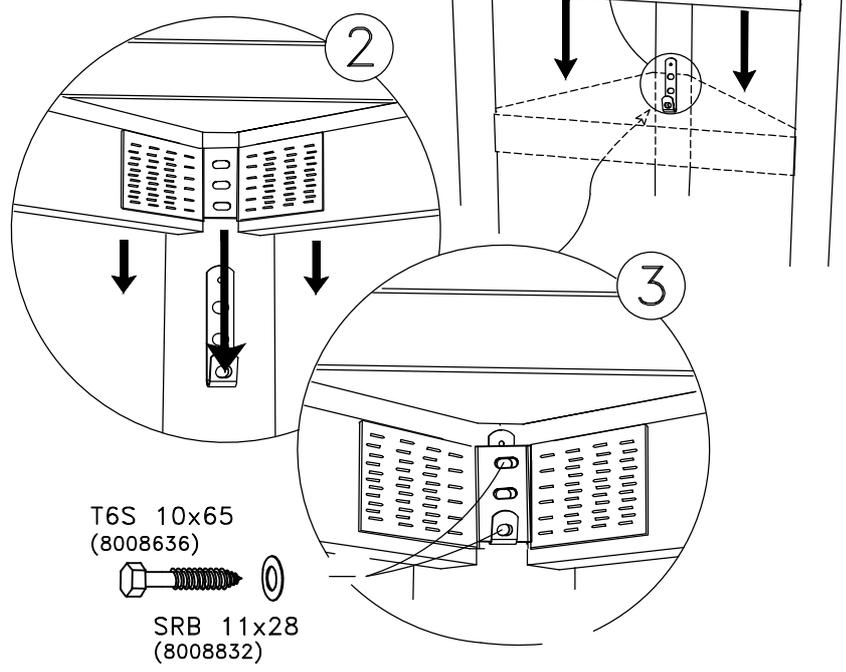

HAGS ANEBY, SWEDEN
+46(0)380-47300
www.hags.com

Floor
426 151
1(1)

 TJ  OG | 2013-02-26 | 1