

HAGS®

Rocking Equipment: 2 Seater

MASW38846

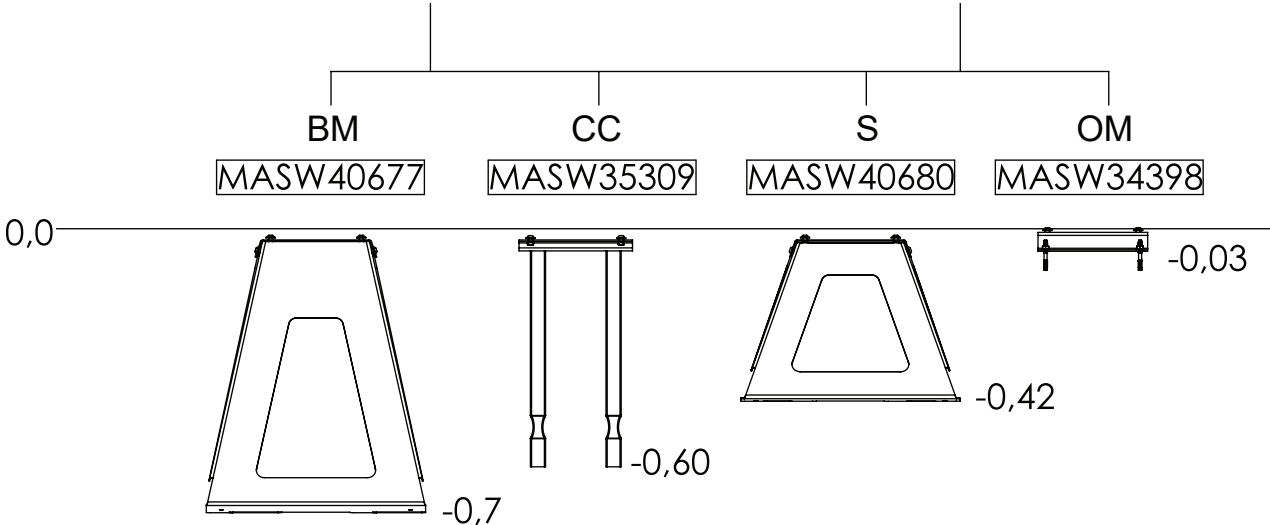

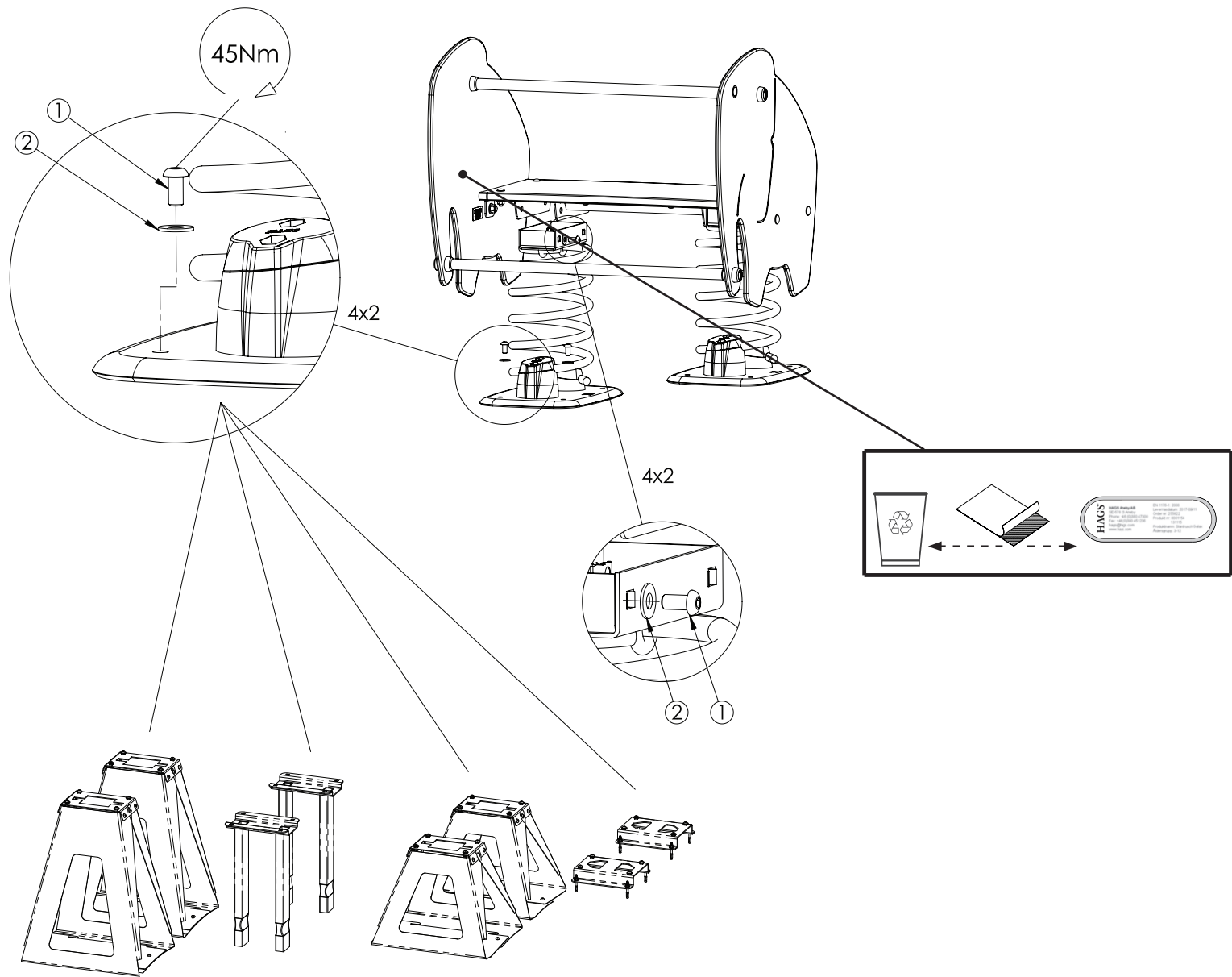

NR.	Description MA	Item Number	Qty
1	MK6S M10x20 mm	8008451	16
2	Ø11x24x2 mm	8008850	16

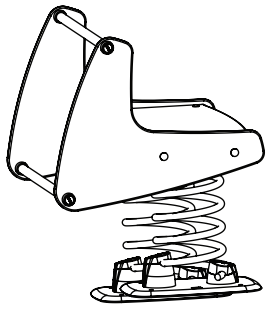

SW3821

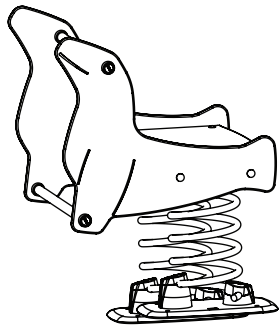

SW38345

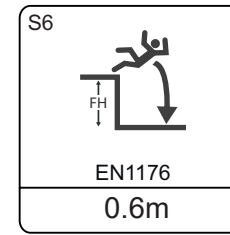

EN 1176

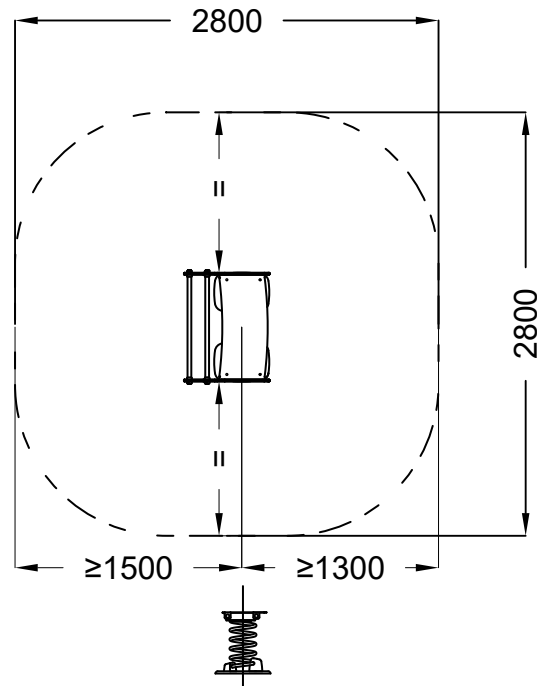

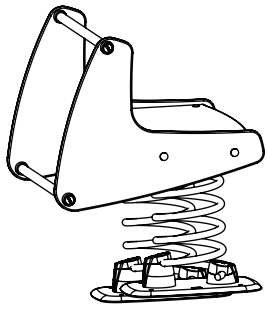

SW3821

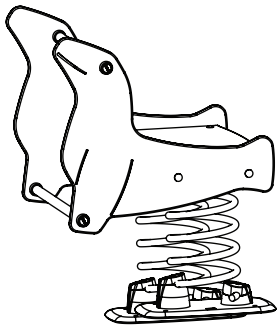

SW38345

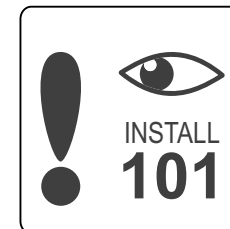
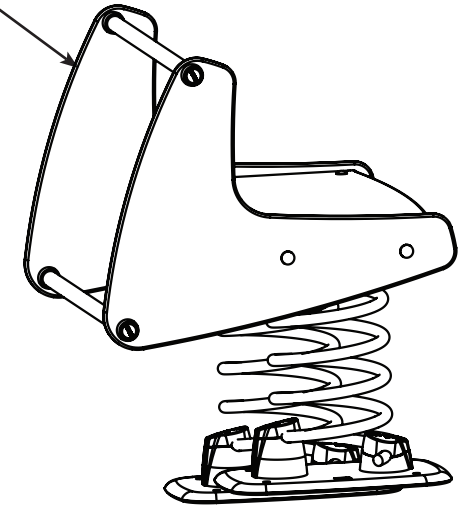
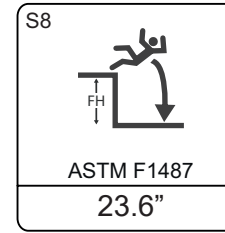
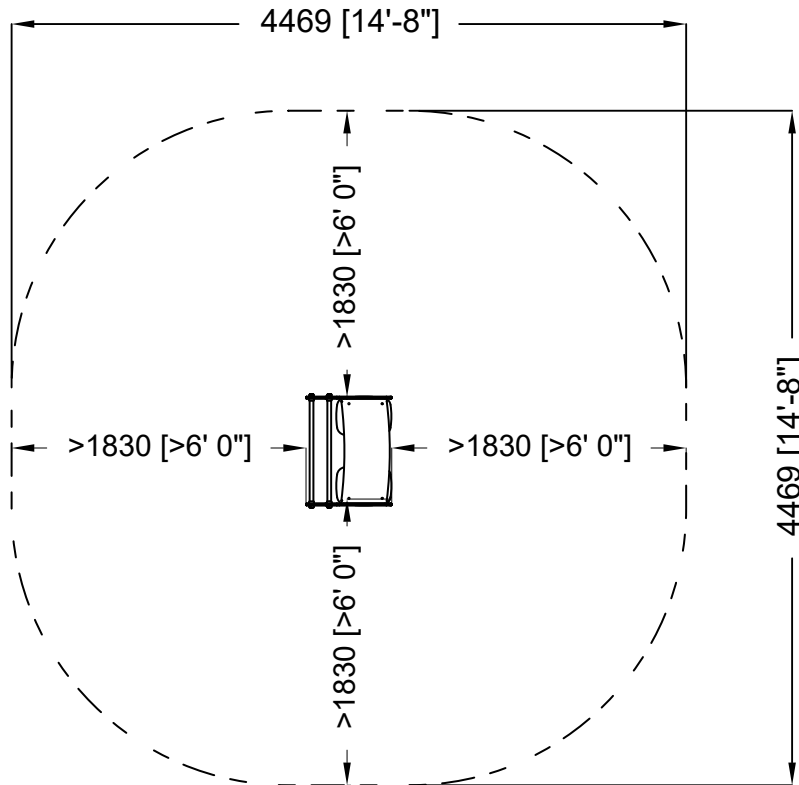

WARNING
 Playground equipment installed over hard surfaces such as concrete, asphalt or packed earth may result in serious injury or death from falls. Make sure that appropriate safety surfacing is present, before allowing children to play.

WARNING
 Children have strangled and died while their clothes caught on slides and other playground equipment. Before allowing children to play, remove helmets, scarves, necklaces, hood cords, neck drawstrings, and mittens connected through the sleeves. Also, remove any foreign ropes, strings, or shoe laces that may be tied to equipment.

WARNING
 All playground equipment and rubber surfacing may become hot enough to cause burns. Check for hot surfaces before allowing children to play. Children should wear appropriate shoes at all times.

WARNING
 Playing tag or running on or under playground equipment can lead to serious injuries from falls, collisions, and head strikes. Do not run on or under playground equipment. Pay attention while playing and be careful.

“play smart” rules

- ✓ Do not play on broken or damaged equipment. Report it.
- ✓ Do not play without adequate safety surfacing below and around equipment.
- ✓ No helmets, necklaces or drawstrings should be worn while on equipment.
- ✓ Be careful of hot paly surfaces and always wear shoes while playing.
- ✓ Do not play tag or run on playground equipment and do not jump off of equipment.
- ✓ Watch your head! Do not run under bridges, decks, stairs, or other equipment.
- ✓ Be careful when equipment is wet.
- ✓ Do not play on snowy or icy equipment.
- ✓ Do not climb on roofs, railings, or posts, or on top of crawl through tube slides.
- ✓ Slide sitting down, feet first, and one at a time. Do not slide up chutes or tubes.
- ✓ Adults – do not slide with a child on your lap. It can injure your child’s legs.
- ✓ Before letting go of overhead bars, hang down still, bend your knees a little and drop straight down with both feet.
- ✓ Swing sitting down and do not jump out while swinging. Do not twist chains.

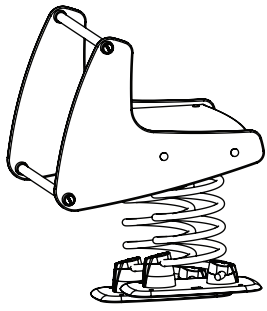

SW3821

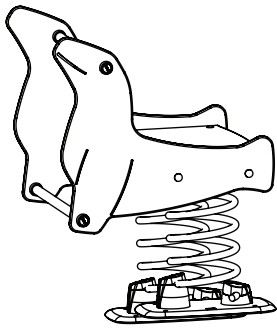

SW38345

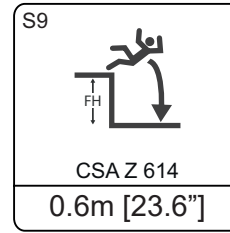
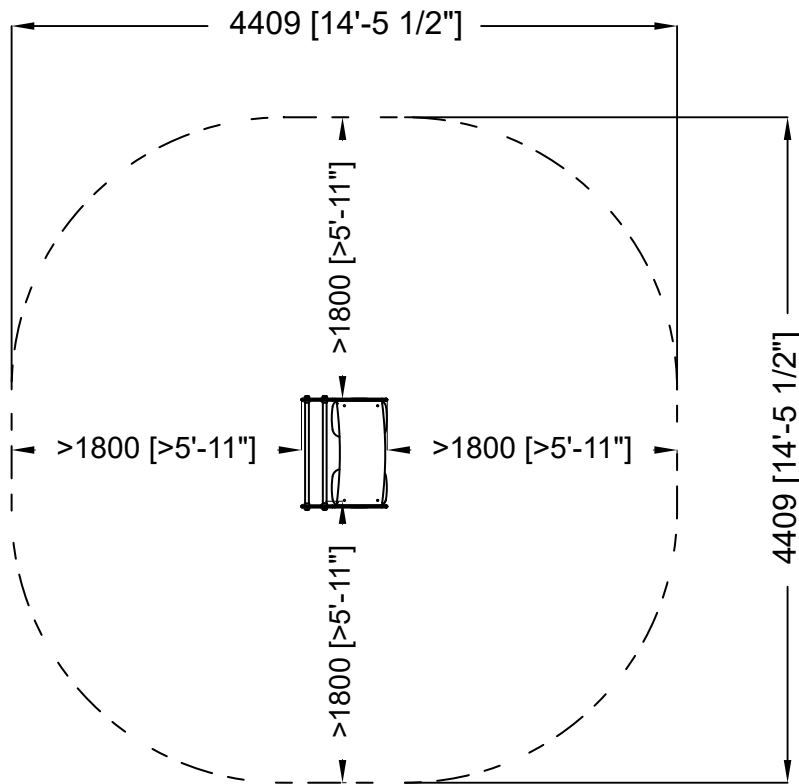

CSA Z 614

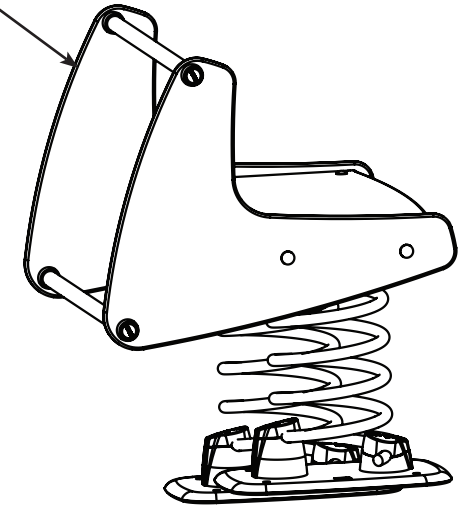

WARNING
 Playground equipment installed over hard surfaces such as concrete, asphalt or packed earth may result in serious injury or death from falls. Make sure that appropriate safety surfacing is present, before allowing children to play.

WARNING
 Children have strangled and died while their clothes caught on slides and other playground equipment. Before allowing children to play, remove helmets, scarves, necklaces, hood cords, neck drawstrings, and mittens connected through the sleeves. Also, remove any foreign ropes, strings, or shoe laces that may be tied to equipment.

WARNING
 All playground equipment and rubber surfacing may become hot enough to cause burns. Check for hot surfaces before allowing children to play. Children should wear appropriate shoes at all times.

WARNING
 Playing tag or running on or under playground equipment can lead to serious injuries from falls, collisions, and head strikes. Do not run on or under playground equipment. Pay attention while playing and be careful.

“play smart” rules

- ✓ Do not play on broken or damaged equipment. Report it.
- ✓ Do not play without adequate safety surfacing below and around equipment.
- ✓ No helmets, necklaces or drawstrings should be worn while on equipment.
- ✓ Be careful of hot paly surfaces and always wear shoes while playing.
- ✓ Do not play tag or run on playground equipment and do not jump off of equipment.
- ✓ Watch your head! Do not run under bridges, decks, stairs, or other equipment.
- ✓ Be careful when equipment is wet.
- ✓ Do not play on snowy or icy equipment.
- ✓ Do not climb on roofs, railings, or posts, or on top of crawl through tube slides.
- ✓ Slide sitting down, feet first, and one at a time. Do not slide up chutes or tubes.
- ✓ Adults – do not slide with a child on your lap. It can injure your child’s legs.
- ✓ Before letting go of overhead bars, hang down still, bend your knees a little and drop straight down with both feet.
- ✓ Swing sitting down and do not jump out while swinging. Do not twist chains.

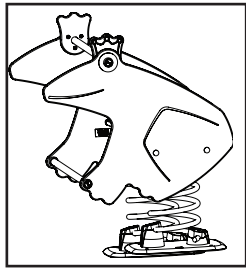

SW38253

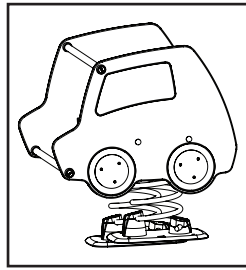

SW38170

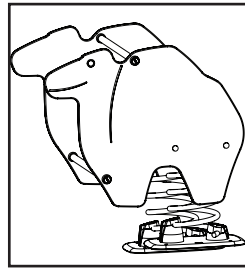

SW38295

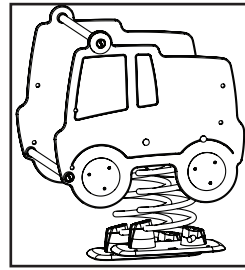

SW38366

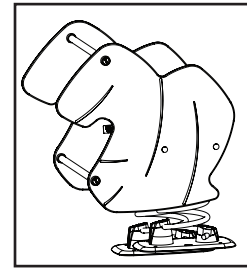

SW38274

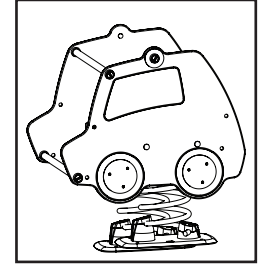

SW38143

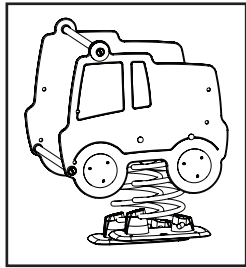

SW38366

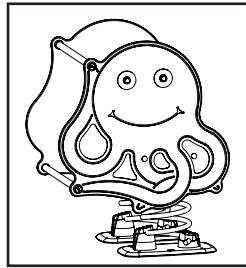

SW47908

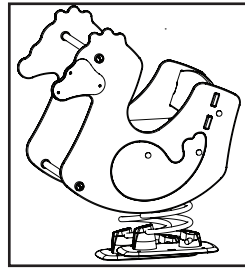

SW38627

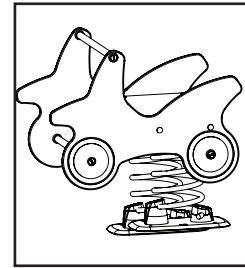

SW38459

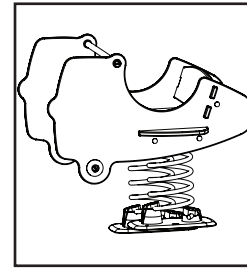

SW38671

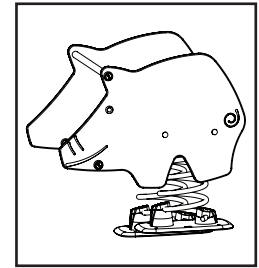

SW38197

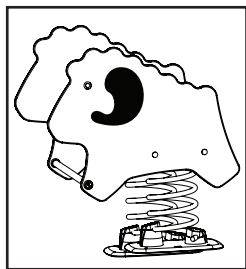

SW38087

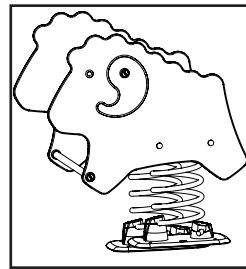

SW83213

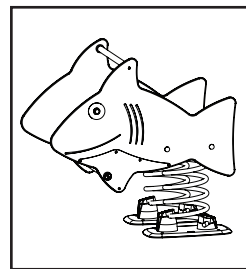

SW47910

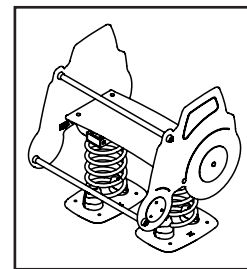

SW38092

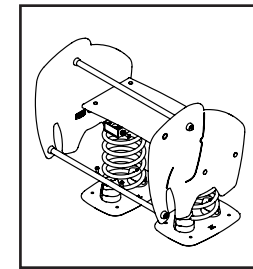

SW38232

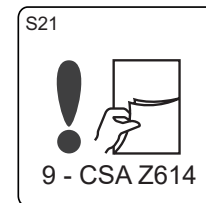
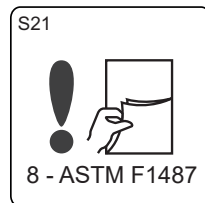
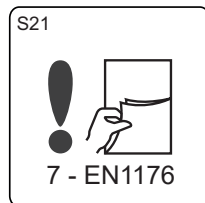

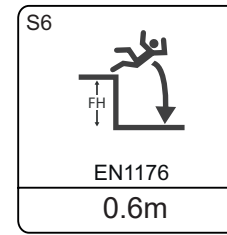

EN 1176

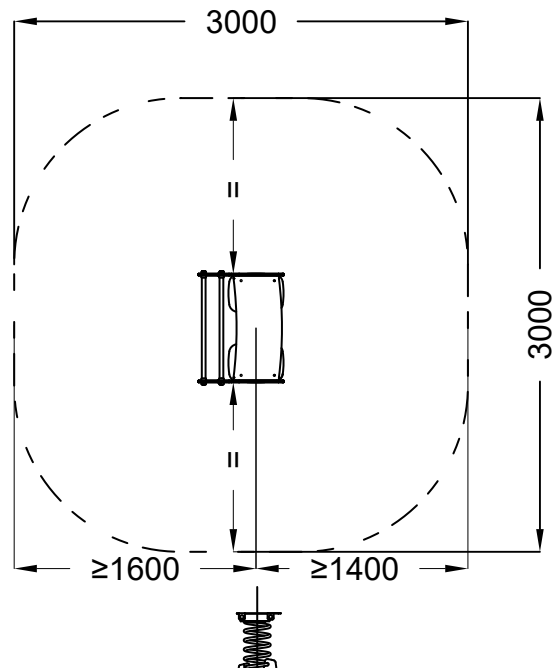



ASTM F1487

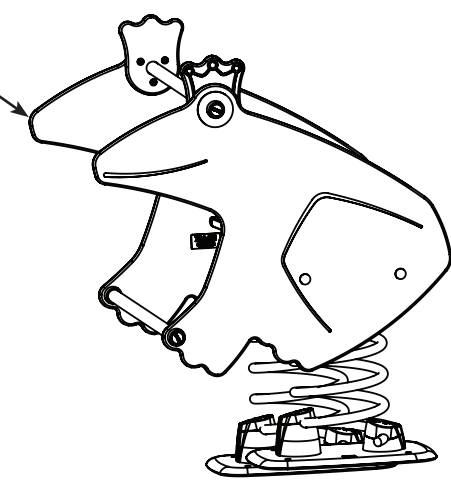
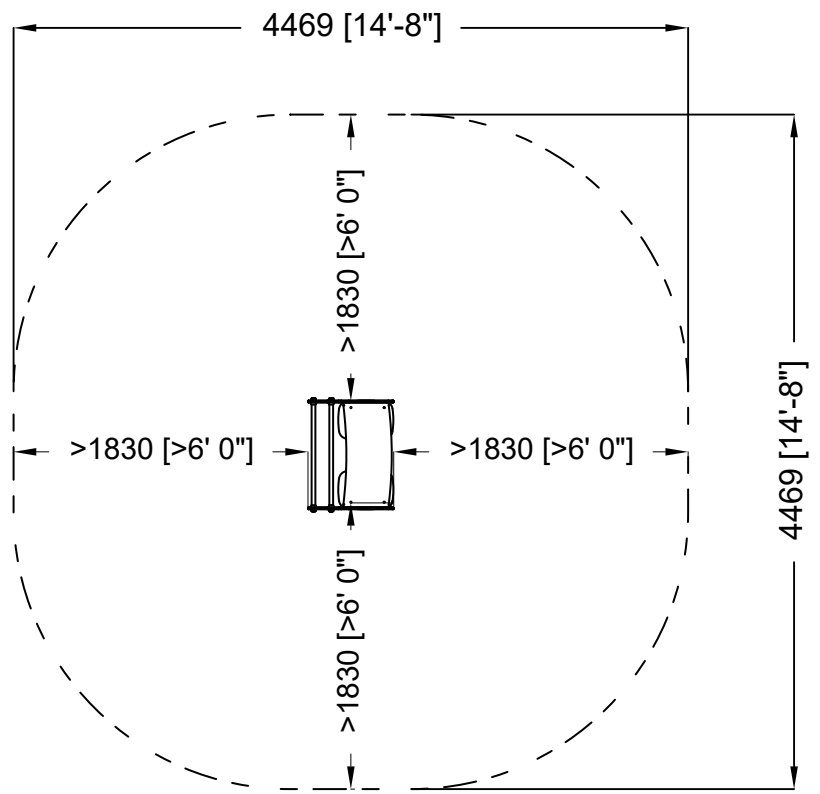
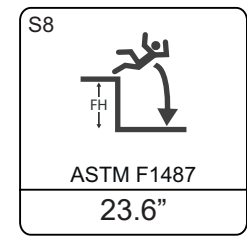

WARNING
 Playground equipment installed over hard surfaces such as concrete, asphalt or packed earth may result in serious injury or death from falls. Make sure that appropriate safety surfacing is present, before allowing children to play.

WARNING
 Children have strangled and died while their clothes caught on slides and other playground equipment. Before allowing children to play, remove helmets, scarves, necklaces, hood cords, neck drawstrings, and mittens connected through the sleeves. Also, remove any foreign ropes, strings, or shoe laces that may be tied to equipment.

WARNING
 All playground equipment and rubber surfacing may become hot enough to cause burns. Check for hot surfaces before allowing children to play. Children should wear appropriate shoes at all times.

WARNING
 Playing tag or running on or under playground equipment can lead to serious injuries from falls, collisions, and head strikes. Do not run on or under playground equipment. Pay attention while playing and be careful.

“play smart” rules

- ✓ Do not play on broken or damaged equipment. Report it.
- ✓ Do not play without adequate safety surfacing below and around equipment.
- ✓ No helmets, necklaces or drawstrings should be worn while on equipment.
- ✓ Be careful of hot paly surfaces and always wear shoes while playing.
- ✓ Do not play tag or run on playground equipment and do not jump off of equipment.
- ✓ Watch your head! Do not run under bridges, decks, stairs, or other equipment.
- ✓ Be careful when equipment is wet.
- ✓ Do not play on snowy or icy equipment.
- ✓ Do not climb on roofs, railings, or posts, or on top of crawl through tube slides.
- ✓ Slide sitting down, feet first, and one at a time. Do not slide up chutes or tubes.
- ✓ Adults – do not slide with a child on your lap. It can injure your child’s legs.
- ✓ Before letting go of overhead bars, hang down still, bend your knees a little and drop straight down with both feet.
- ✓ Swing sitting down and do not jump out while swinging. Do not twist chains.

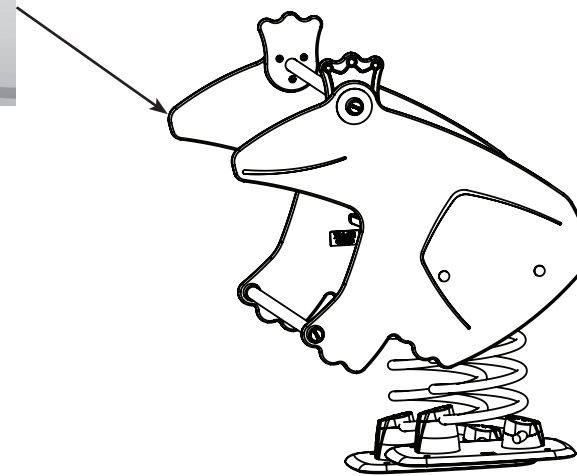
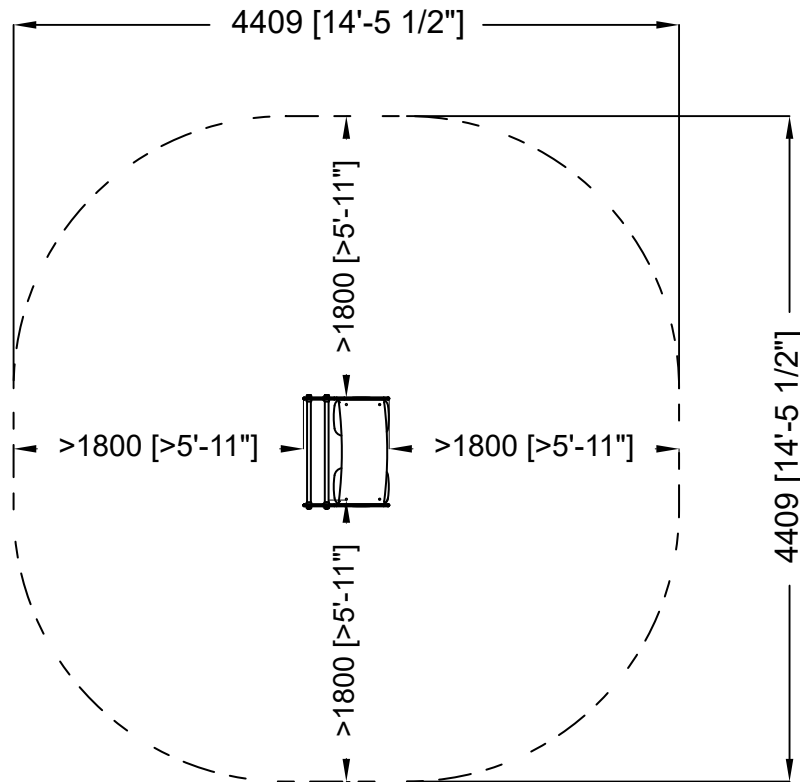
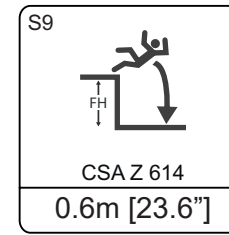

WARNING
 Playground equipment installed over hard surfaces such as concrete, asphalt or packed earth may result in serious injury or death from falls. Make sure that appropriate safety surfacing is present, before allowing children to play.

WARNING
 Children have strangled and died while their clothes caught on slides and other playground equipment. Before allowing children to play, remove helmets, scarves, necklaces, hood cords, neck drawstrings, and mittens connected through the sleeves. Also, remove any foreign ropes, strings, or shoe laces that may be tied to equipment.

WARNING
 All playground equipment and rubber surfacing may become hot enough to cause burns. Check for hot surfaces before allowing children to play. Children should wear appropriate shoes at all times.

WARNING
 Playing tag or running on or under playground equipment can lead to serious injuries from falls, collisions, and head strikes. Do not run on or under playground equipment. Pay attention while playing and be careful.

“play smart” rules

- ✓ Do not play on broken or damaged equipment. Report it.
- ✓ Do not play without adequate safety surfacing below and around equipment.
- ✓ No helmets, necklaces or drawstrings should be worn while on equipment.
- ✓ Be careful of hot paly surfaces and always wear shoes while playing.
- ✓ Do not play tag or run on playground equipment and do not jump off of equipment.
- ✓ Watch your head! Do not run under bridges, decks, stairs, or other equipment.
- ✓ Be careful when equipment is wet.
- ✓ Do not play on snowy or icy equipment.
- ✓ Do not climb on roofs, railings, or posts, or on top of crawl through tube slides.
- ✓ Slide sitting down, feet first, and one at a time. Do not slide up chutes or tubes.
- ✓ Adults – do not slide with a child on your lap. It can injure your child’s legs.
- ✓ Before letting go of overhead bars, hang down still, bend your knees a little and drop straight down with both feet.
- ✓ Swing sitting down and do not jump out while swinging. Do not twist chains.