

HAGS[®]

Rocking Equipment

MASW36720

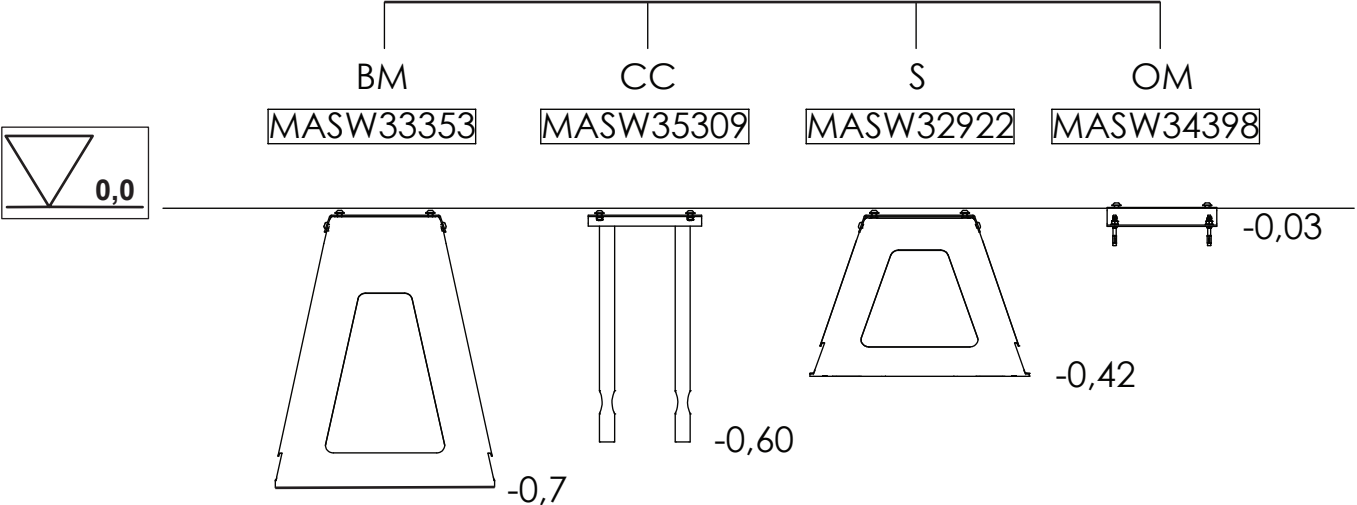

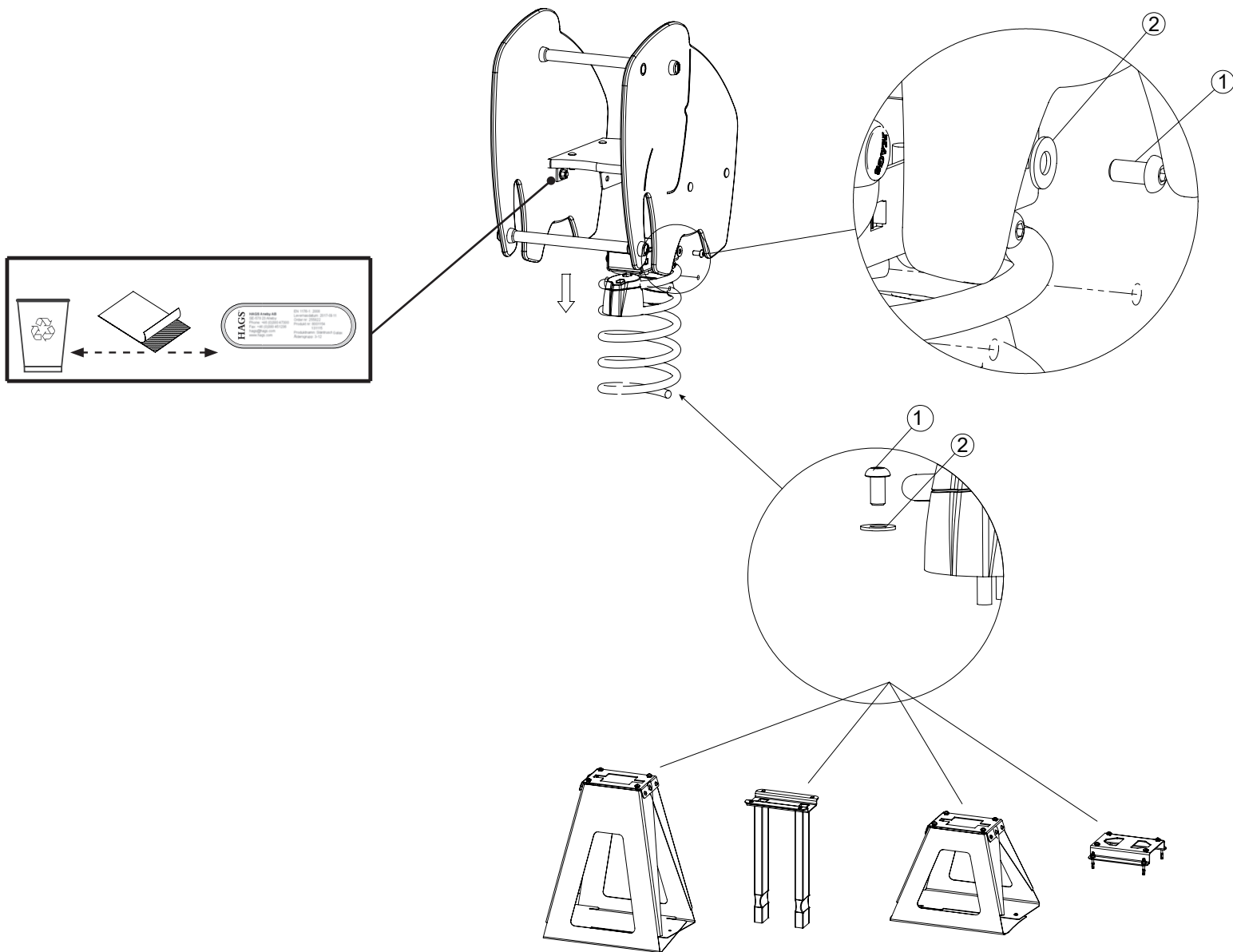

NR.	Description MA	Item Number	Qty
1	MK6S M10x20 mm	8008451	8
2	Ø11x24x2 mm	8008850	8

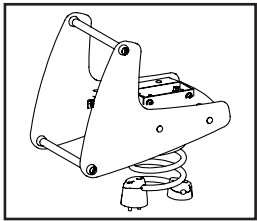

SW34060

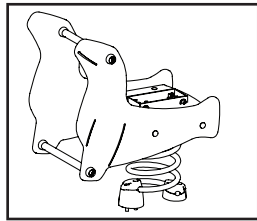

SW34061

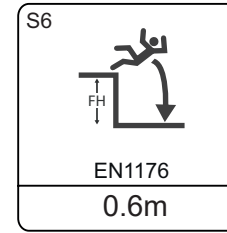

EN 1176

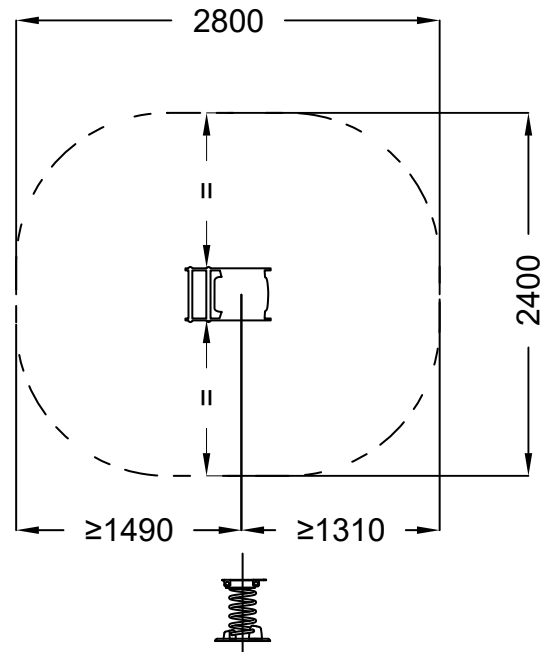

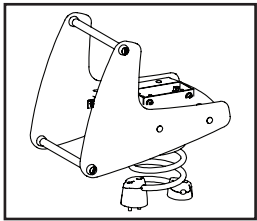

SW34060

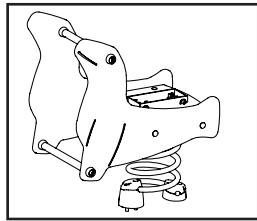

SW34061

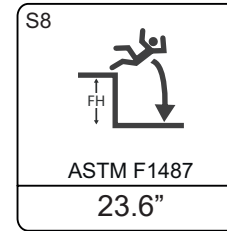

ASTM F1487

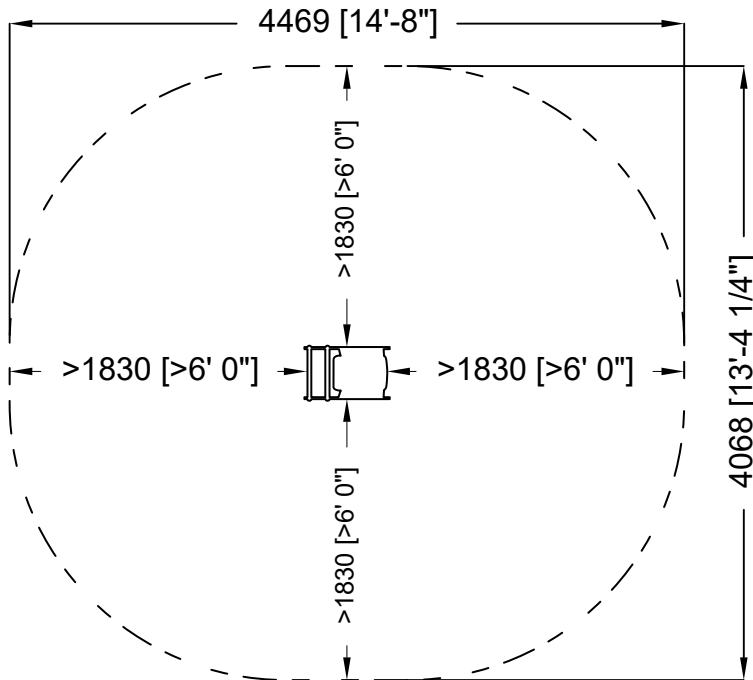
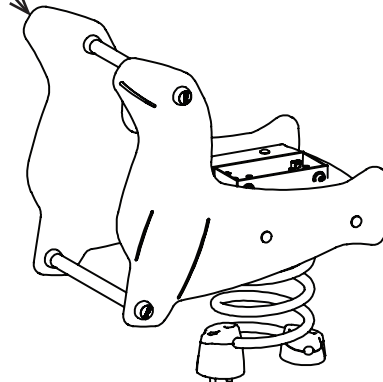

WARNING
 Playground equipment installed over hard surfaces such as concrete, asphalt or packed earth may result in serious injury or death from falls. Make sure that appropriate safety surfacing is present, before allowing children to play.

WARNING
 Children have strangled and died while their clothes caught on slides and other playground equipment. Before allowing children to play, remove helmets, scarves, necklaces, hood cords, neck drawstrings, and mittens connected through the sleeves. Also, remove any foreign ropes, strings, or shoe laces that may be tied to equipment.

WARNING
 All playground equipment and rubber surfacing may become hot enough to cause burns. Check for hot surfaces before allowing children to play. Children should wear appropriate shoes at all times.

WARNING
 Playing tag or running on or under playground equipment can lead to serious injuries from falls, collisions, and head strikes. Do not run on or under playground equipment. Pay attention while playing and be careful.

“play smart” rules

- ✓ Do not play on broken or damaged equipment. Report it.
- ✓ Do not play without adequate safety surfacing below and around equipment.
- ✓ No helmets, necklaces or drawstrings should be worn while on equipment.
- ✓ Be careful of hot paly surfaces and always wear shoes while playing.
- ✓ Do not play tag or run on playground equipment and do not jump off of equipment.
- ✓ Watch your head! Do not run under bridges, decks, stairs, or other equipment.
- ✓ Be careful when equipment is wet.
- ✓ Do not play on snowy or icy equipment.
- ✓ Do not climb on roofs, railings, or posts, or on top of crawl through tube slides.
- ✓ Slide sitting down, feet first, and one at a time. Do not slide up chutes or tubes.
- ✓ Adults - do not slide with a child on your lap. It can injure your child's legs.
- ✓ Before letting go of overhead bars, hang down still, bend your knees a little and drop straight down with both feet.
- ✓ Swing sitting down and do not jump out while swinging. Do not twist chains.

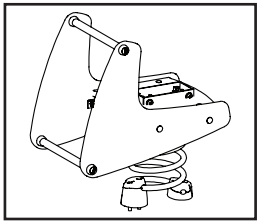

SW34060

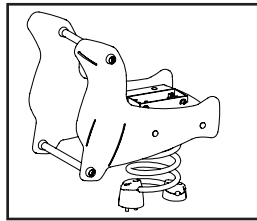

SW34061

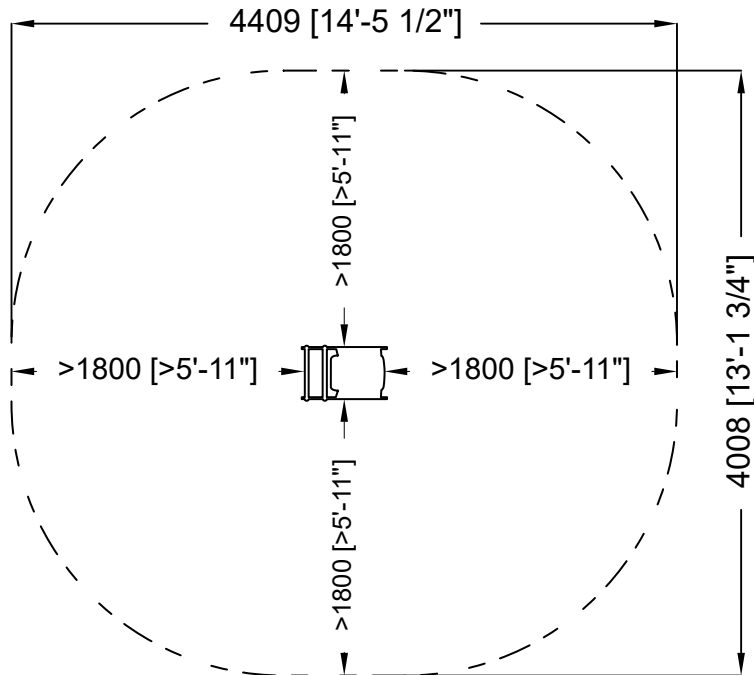
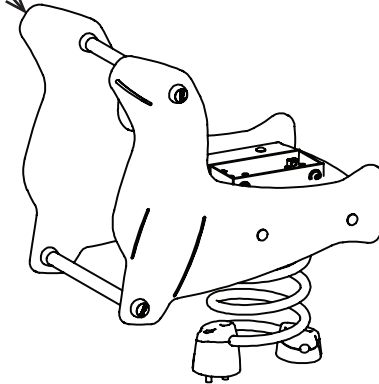
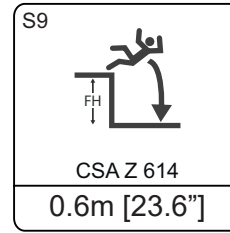

WARNING
 Playground equipment installed over hard surfaces such as concrete, asphalt or packed earth may result in serious injury or death from falls. Make sure that appropriate safety surfacing is present, before allowing children to play.

WARNING
 Children have strangled and died while their clothes caught on slides and other playground equipment. Before allowing children to play, remove helmets, scarves, necklaces, hood cords, neck drawstrings, and mittens connected through the sleeves. Also, remove any foreign ropes, strings, or shoe laces that may be tied to equipment.

WARNING
 All playground equipment and rubber surfacing may become hot enough to cause burns. Check for hot surfaces before allowing children to play. Children should wear appropriate shoes at all times.

WARNING
 Playing tag or running on or under playground equipment can lead to serious injuries from falls, collisions, and head strikes. Do not run on or under playground equipment. Pay attention while playing and be careful.

"play smart" rules

- ✓ Do not play on broken or damaged equipment. Report it.
- ✓ Do not play without adequate safety surfacing below and around equipment.
- ✓ No helmets, necklaces or drawstrings should be worn while on equipment.
- ✓ Be careful of hot paly surfaces and always wear shoes while playing.
- ✓ Do not play tag or run on playground equipment and do not jump off of equipment.
- ✓ Watch your head! Do not run under bridges, decks, stairs, or other equipment.
- ✓ Be careful when equipment is wet.
- ✓ Do not play on snowy or icy equipment.
- ✓ Do not climb on roofs, railings, or posts, or on top of crawl through tube slides.
- ✓ Slide sitting down, feet first, and one at a time. Do not slide up chutes or tubes.
- ✓ Adults - do not slide with a child on your lap. It can injure your child's legs.
- ✓ Before letting go of overhead bars, hang down still, bend your knees a little and drop straight down with both feet.
- ✓ Swing sitting down and do not jump out while swinging. Do not twist chains.

SW34063

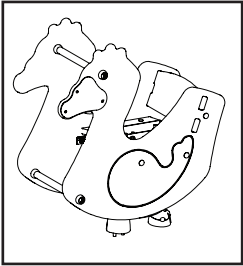

SW34053

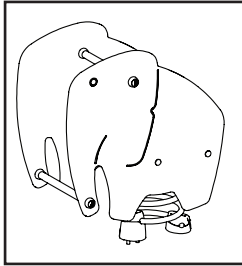

SW34065

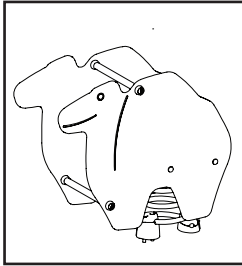

SW34056

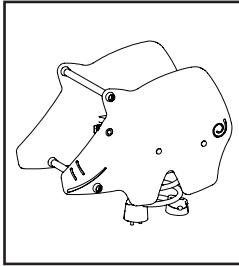

SW34059

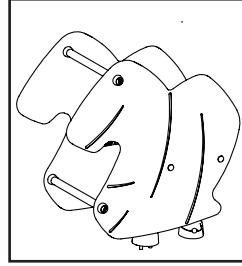

SW34057

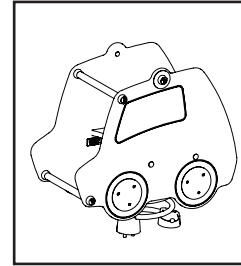

SW47920

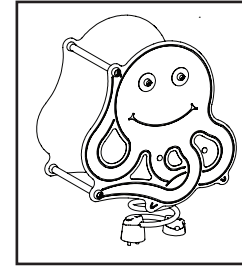

SW47920

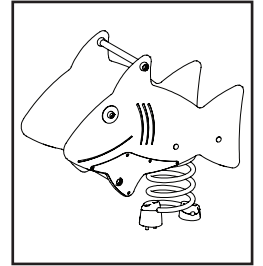

SW34062

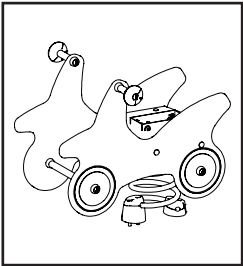

SW34058

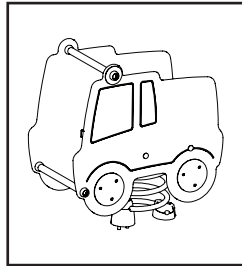

SW34051

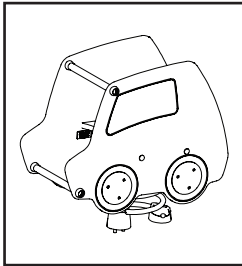

SW34064

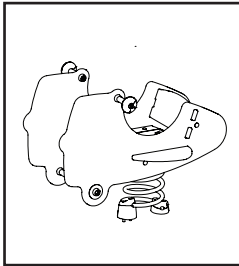

32-07526

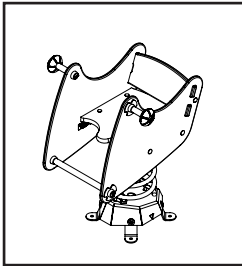

SW34052

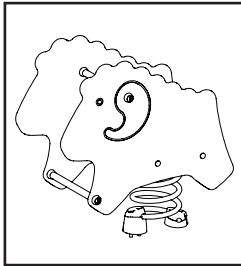

SW34055

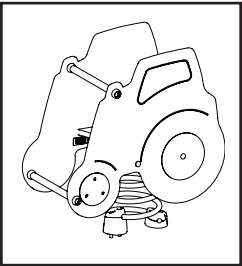

SW34054

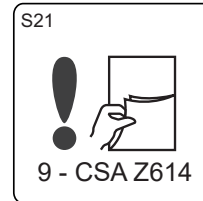
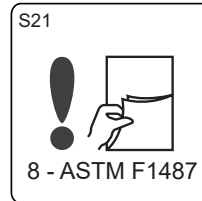
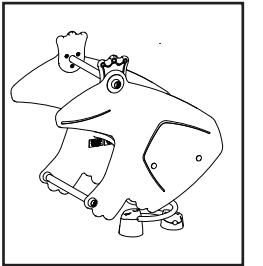

S6

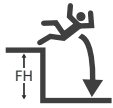

EN1176

0.6



EN 1176

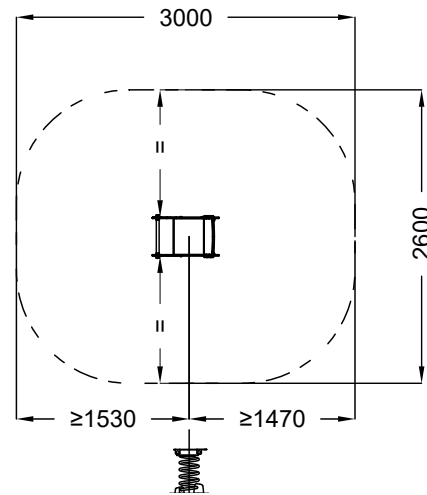

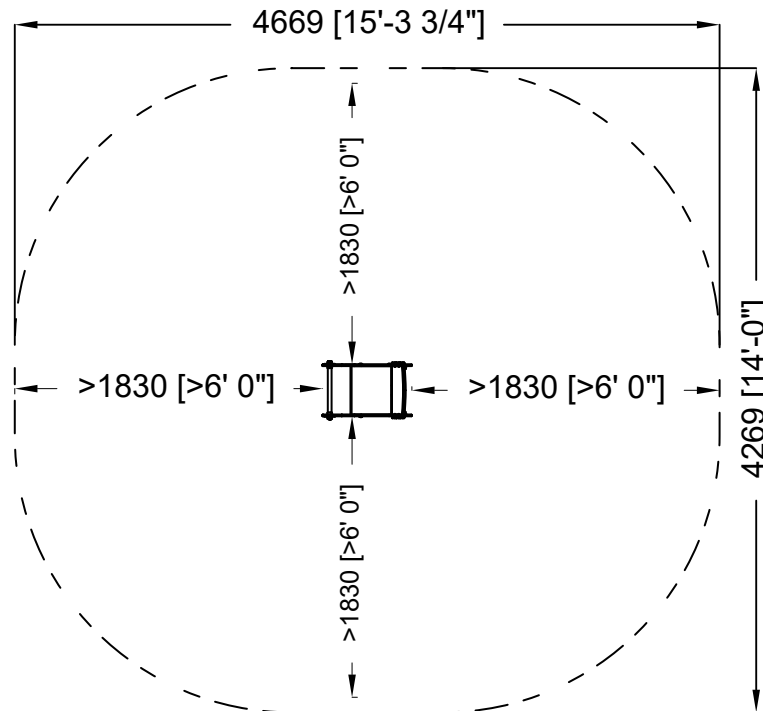
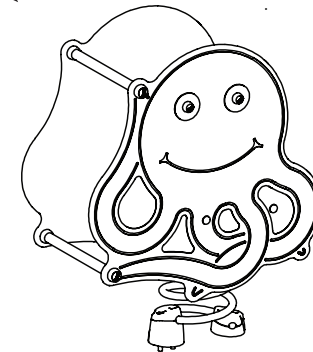
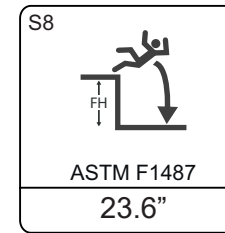

WARNING
 Playground equipment installed over hard surfaces such as concrete, asphalt or packed earth may result in serious injury or death from falls. Make sure that appropriate safety surfacing is present, before allowing children to play.

WARNING
 Children have strangled and died while their clothes caught on slides and other playground equipment. Before allowing children to play, remove helmets, scarves, necklaces, hood cords, neck drawstrings, and mittens connected through the sleeves. Also, remove any foreign ropes, strings, or shoe laces that may be tied to equipment.

WARNING
 All playground equipment and rubber surfacing may become hot enough to cause burns. Check for hot surfaces before allowing children to play. Children should wear appropriate shoes at all times.

WARNING
 Playing tag or running on or under playground equipment can lead to serious injuries from falls, collisions, and head strikes. Do not run on or under playground equipment. Pay attention while playing and be careful.

"play smart" rules

- ✓ Do not play on broken or damaged equipment. Report it.
- ✓ Do not play without adequate safety surfacing below and around equipment.
- ✓ No helmets, necklaces or drawstrings should be worn while on equipment.
- ✓ Be careful of hot paly surfaces and always wear shoes while playing.
- ✓ Do not play tag or run on playground equipment and do not jump off of equipment.
- ✓ Watch your head! Do not run under bridges, decks, stairs, or other equipment.
- ✓ Be careful when equipment is wet.
- ✓ Do not play on snowy or icy equipment.
- ✓ Do not climb on roofs, railings, or posts, or on top of crawl through tube slides.
- ✓ Slide sitting down, feet first, and one at a time. Do not slide up chutes or tubes.
- ✓ Adults - do not slide with a child on your lap. It can injure your child's legs.
- ✓ Before letting go of overhead bars, hang down still, bend your knees a little and drop straight down with both feet.
- ✓ Swing sitting down and do not jump out while swinging. Do not twist chains.

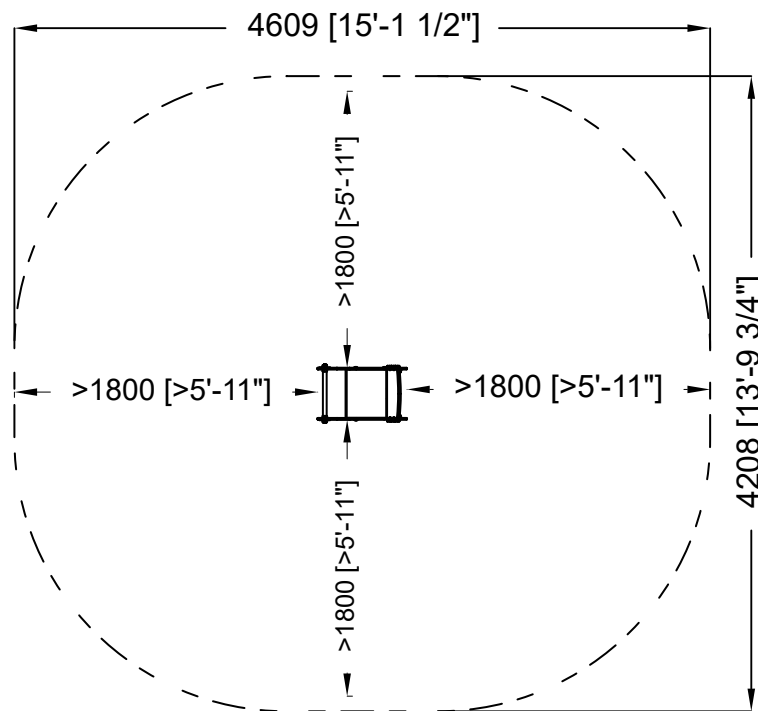
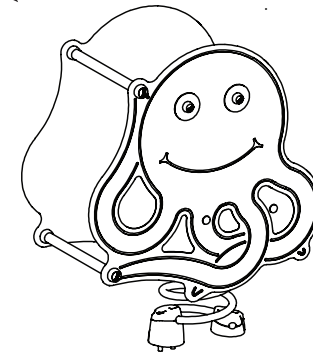
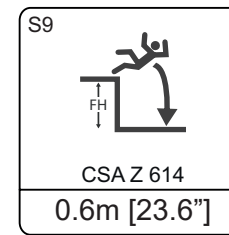

WARNING
 Playground equipment installed over hard surfaces such as concrete, asphalt or packed earth may result in serious injury or death from falls. Make sure that appropriate safety surfacing is present, before allowing children to play.

WARNING
 Children have strangled and died while their clothes caught on slides and other playground equipment. Before allowing children to play, remove helmets, scarves, necklaces, hood cords, neck drawstrings, and mittens connected through the sleeves. Also, remove any foreign ropes, strings, or shoe laces that may be tied to equipment.

WARNING
 All playground equipment and rubber surfacing may become hot enough to cause burns. Check for hot surfaces before allowing children to play. Children should wear appropriate shoes at all times.

WARNING
 Playing tag or running on or under playground equipment can lead to serious injuries from falls, collisions, and head strikes. Do not run on or under playground equipment. Pay attention while playing and be careful.

"play smart" rules

- ✓ Do not play on broken or damaged equipment. Report it.
- ✓ Do not play without adequate safety surfacing below and around equipment.
- ✓ No helmets, necklaces or drawstrings should be worn while on equipment.
- ✓ Be careful of hot paly surfaces and always wear shoes while playing.
- ✓ Do not play tag or run on playground equipment and do not jump off of equipment.
- ✓ Watch your head! Do not run under bridges, decks, stairs, or other equipment.
- ✓ Be careful when equipment is wet.
- ✓ Do not play on snowy or icy equipment.
- ✓ Do not climb on roofs, railings, or posts, or on top of crawl through tube slides.
- ✓ Slide sitting down, feet first, and one at a time. Do not slide up chutes or tubes.
- ✓ Adults - do not slide with a child on your lap. It can injure your child's legs.
- ✓ Before letting go of overhead bars, hang down still, bend your knees a little and drop straight down with both feet.
- ✓ Swing sitting down and do not jump out while swinging. Do not twist chains.