



UniPlay Brann

1,0m 5,0m

[m]

65 m<sup>2</sup>

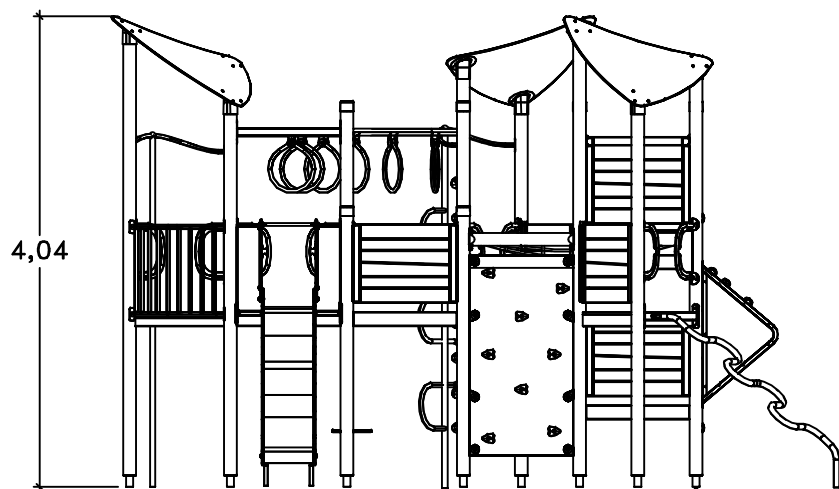
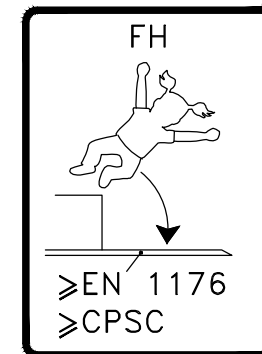
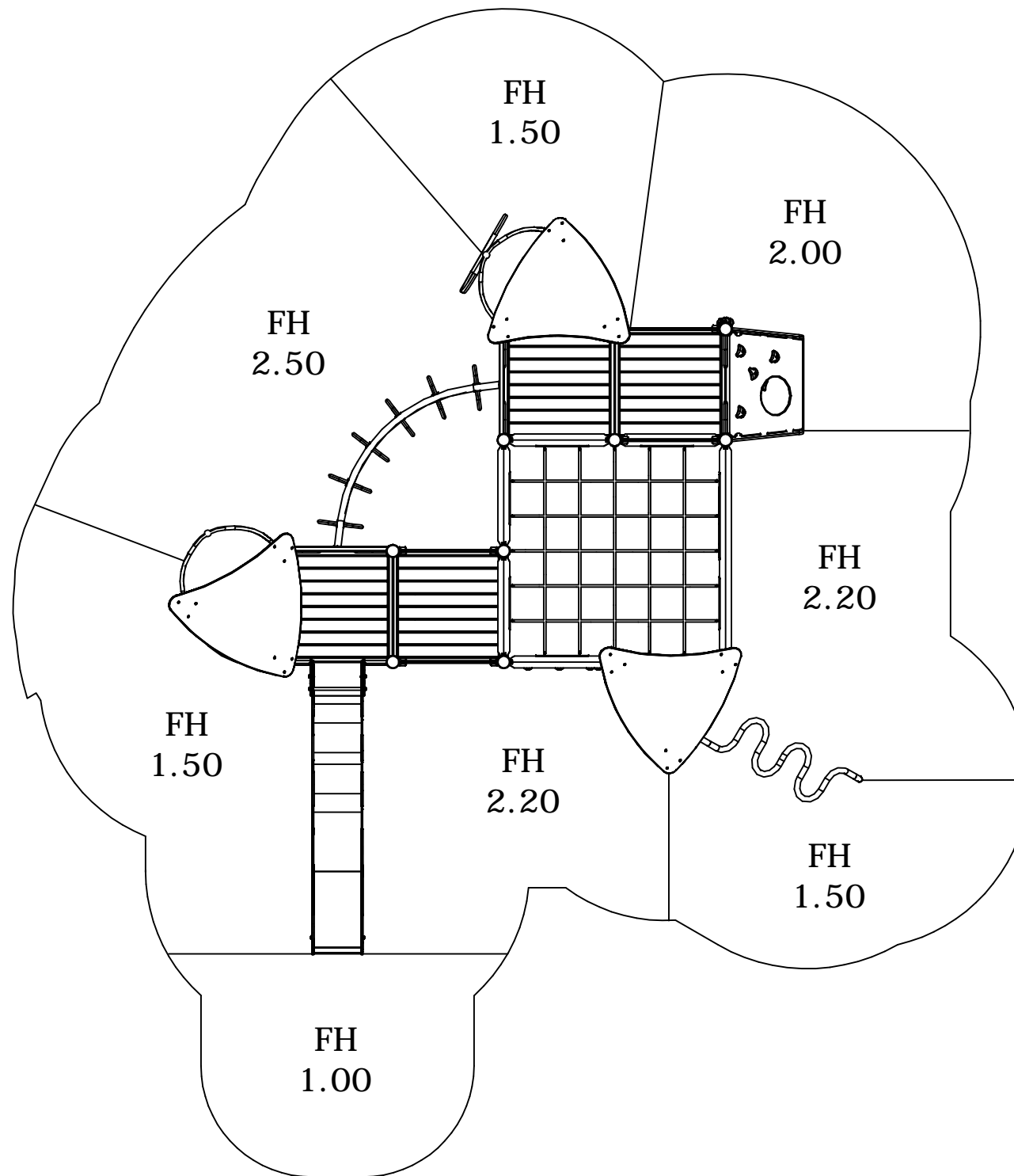
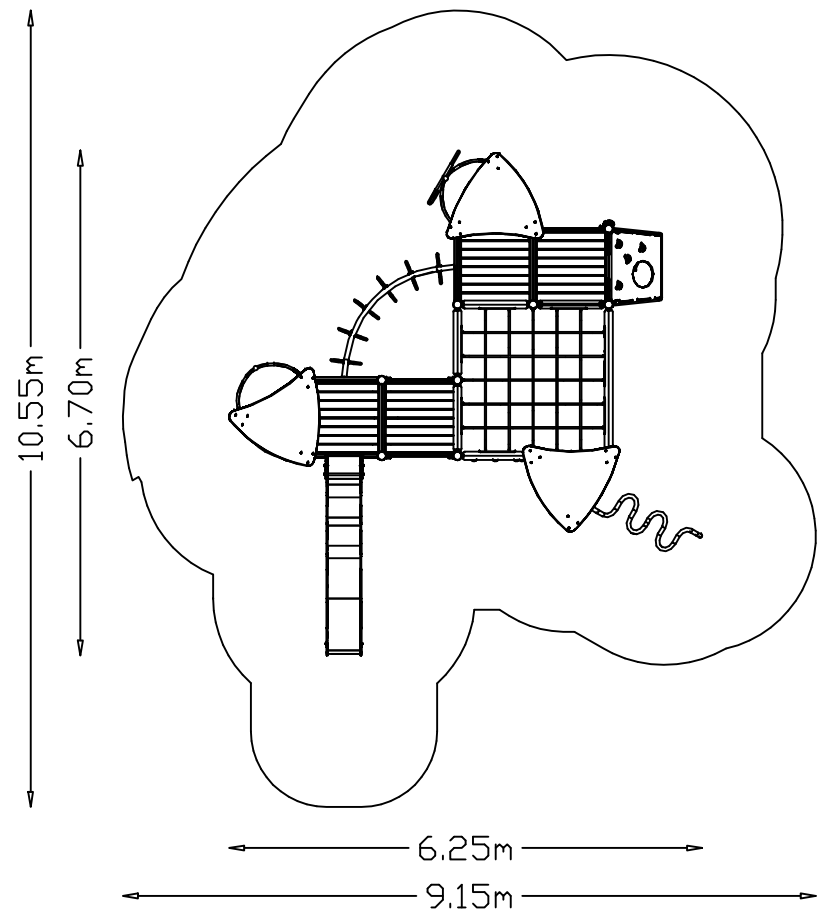

**HAGS** ANEBY, SWEDEN  
+46(0)380-47300  
www.hags.com

UniPlay Brann  
MASW65172  
1/10

LN LN 2019-04-04 1



55h



Varje vecka  
Every week  
Jede woche  
Chaque semaine



Varje säsong  
Every season  
Jedes Jahr  
Chaque saison



Step by Step UniPlay

UNIPLAY  
MASW65172  
SE 1(3)

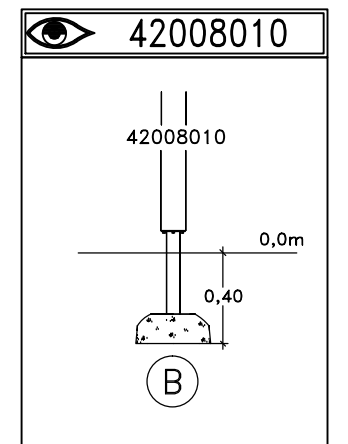
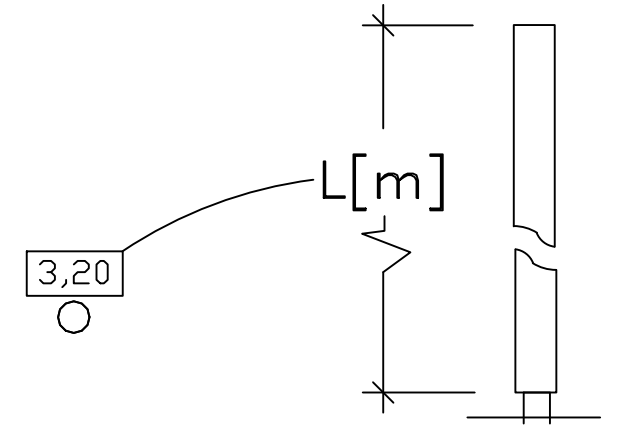
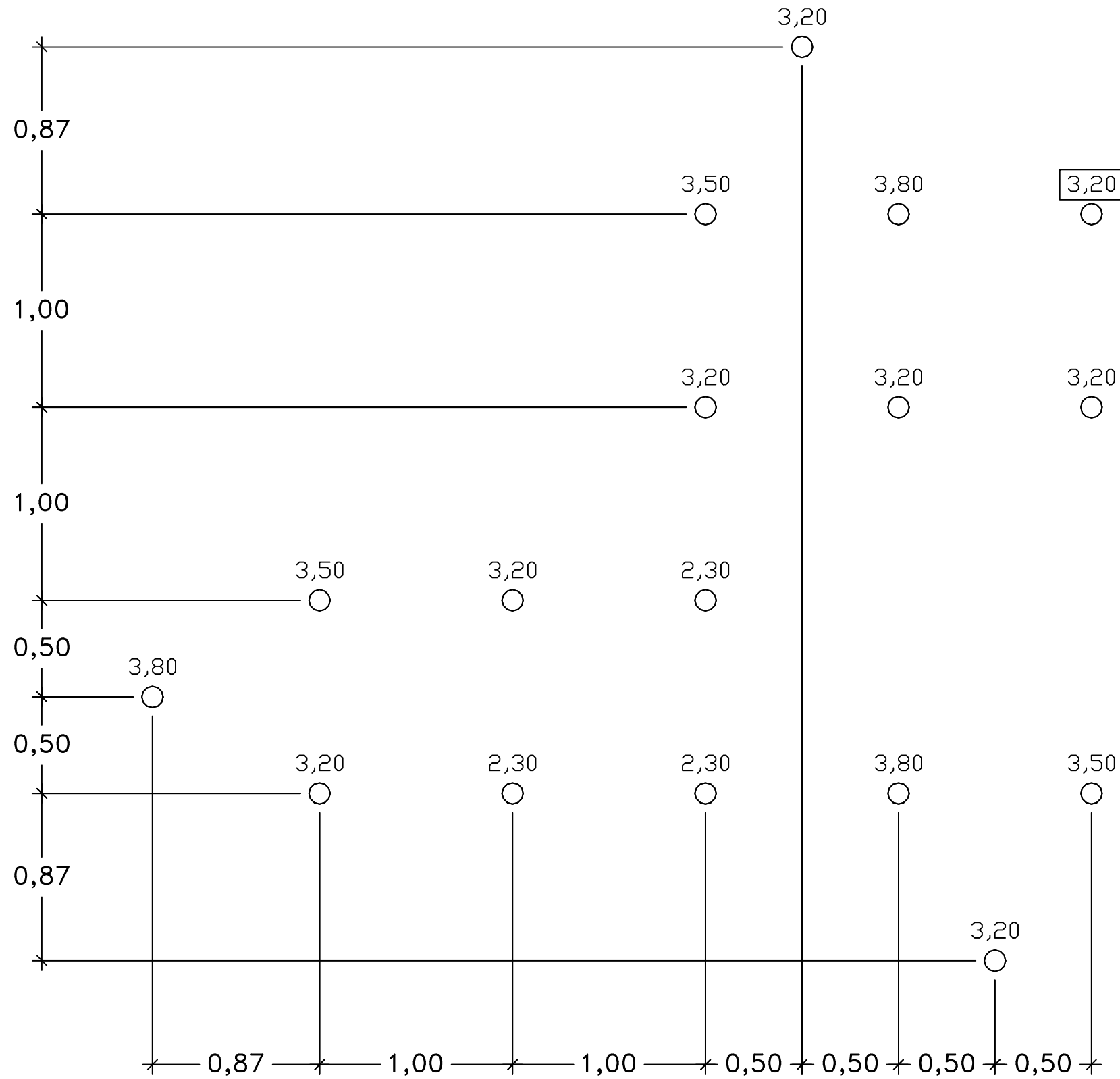
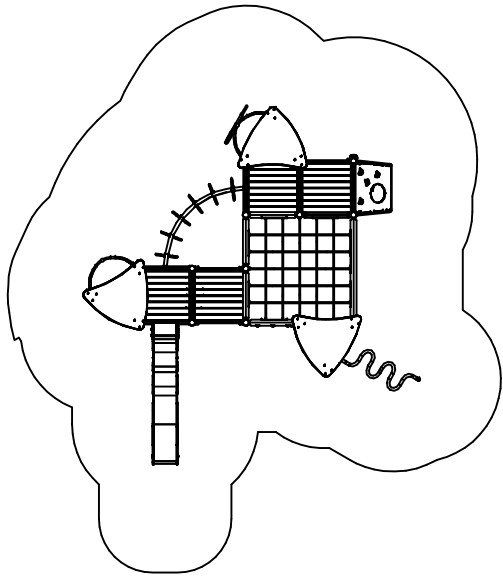

**HAGS** ANEBY, SWEDEN  
 +46(0)380-47300  
 www.hags.com

UniPlay Brann  
 MASW65172  
 2/10

LN LN 2019-04-04 1

# STEP 1

[m]

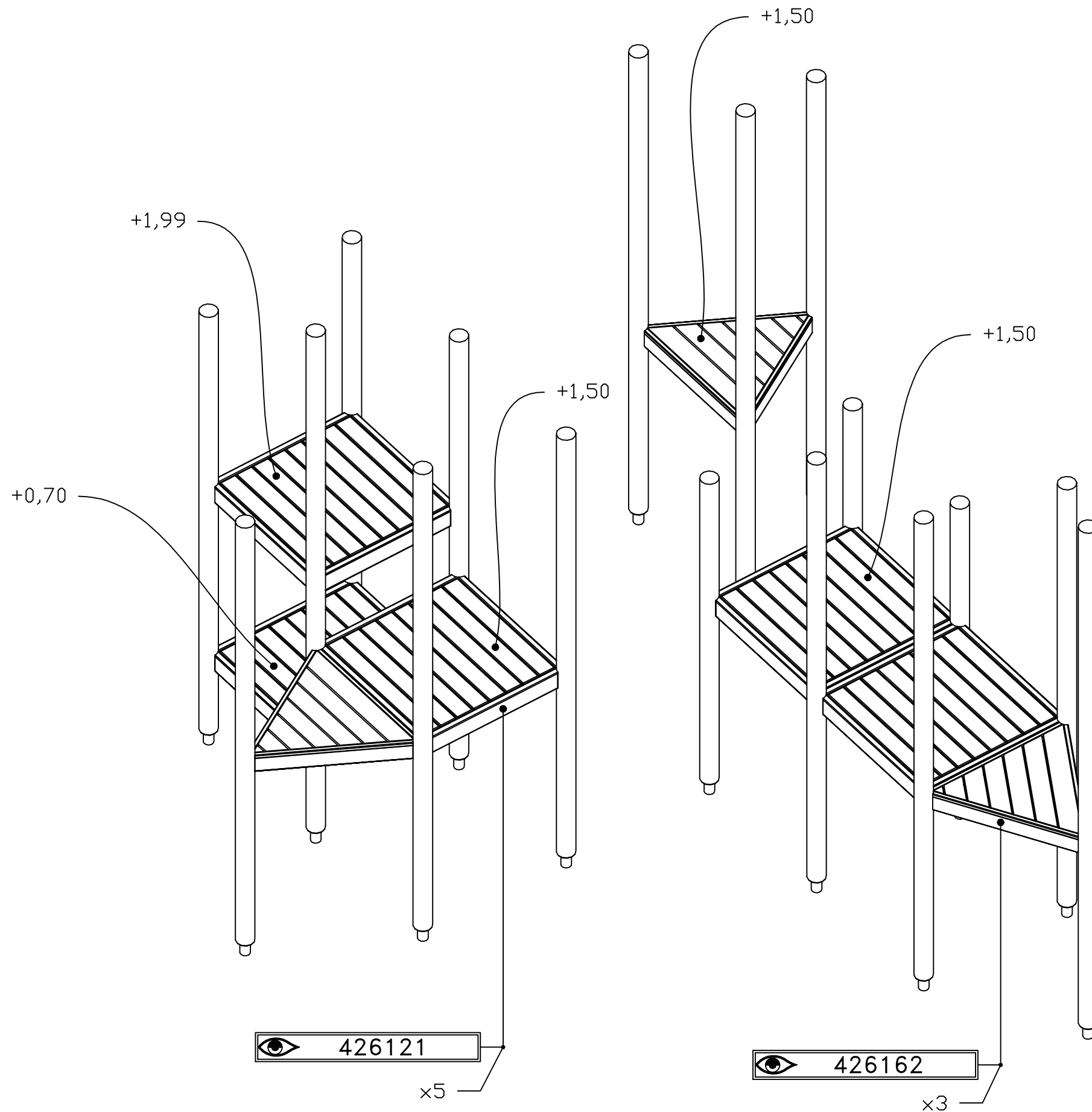
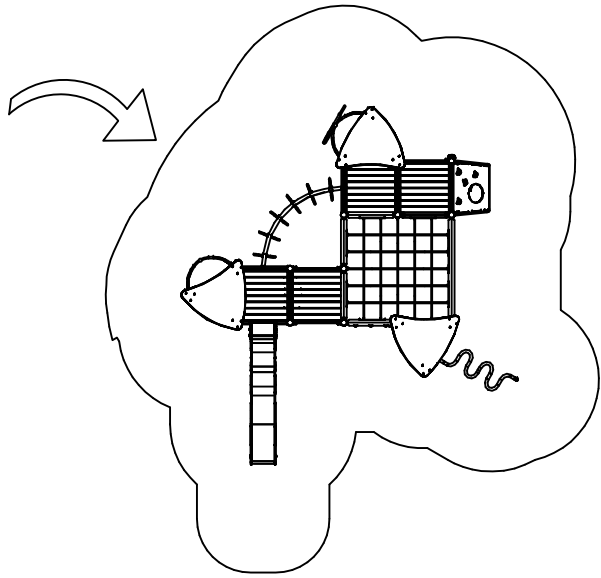

<b>HAGS</b>		ANEBY, SWEDEN	
		+46(0)380-47300	
		www.hags.com	
UniPlay Brann			
MASW65172			
3/10			
	LN		LN
2019-04-04   1			

# STEP 2

[m]

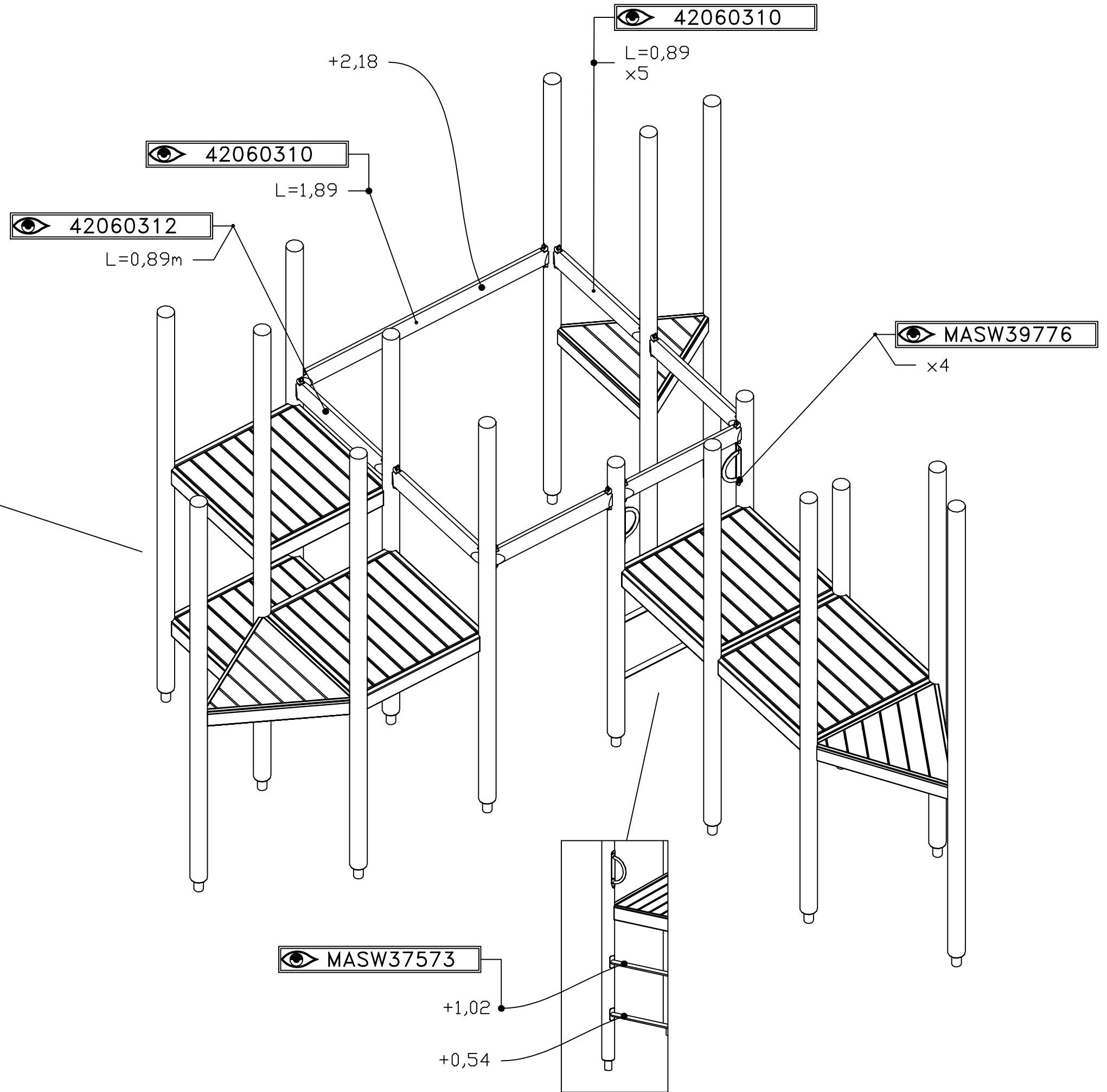
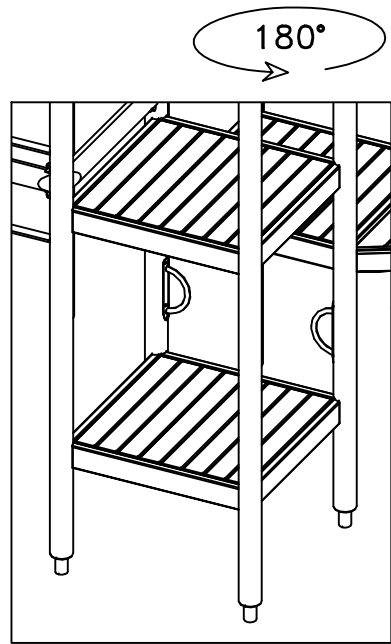
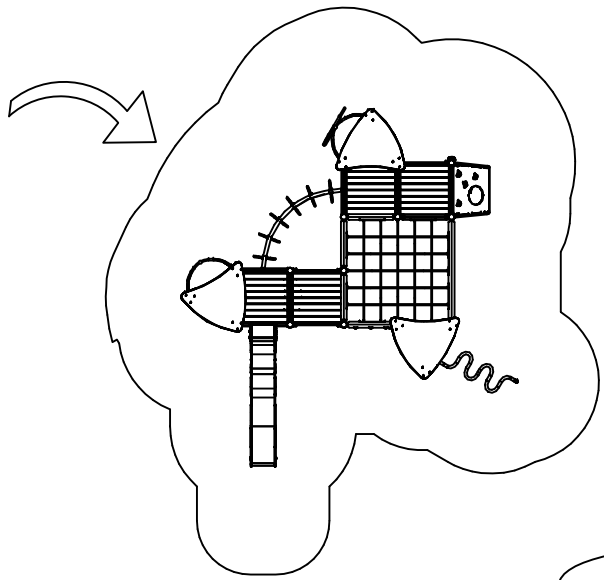

**HAGS** ANEBY, SWEDEN  
+46(0)380-47300  
www.hags.com

UniPlay Brann  
MASW65172  
4/10

LN LN 2019-04-04 1

# STEP 3

[m]

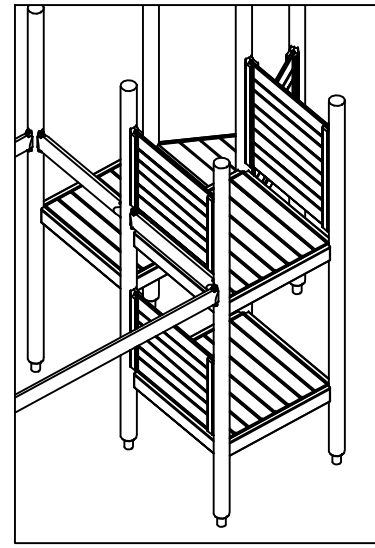
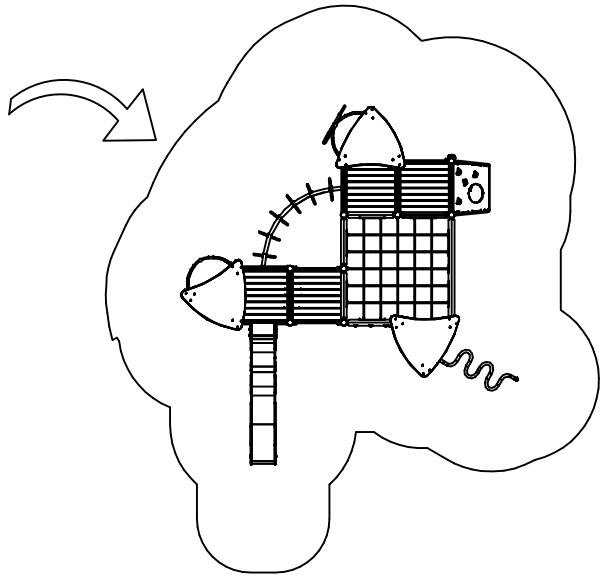

180°

0,89x0,68  
x6

0,89x0,94

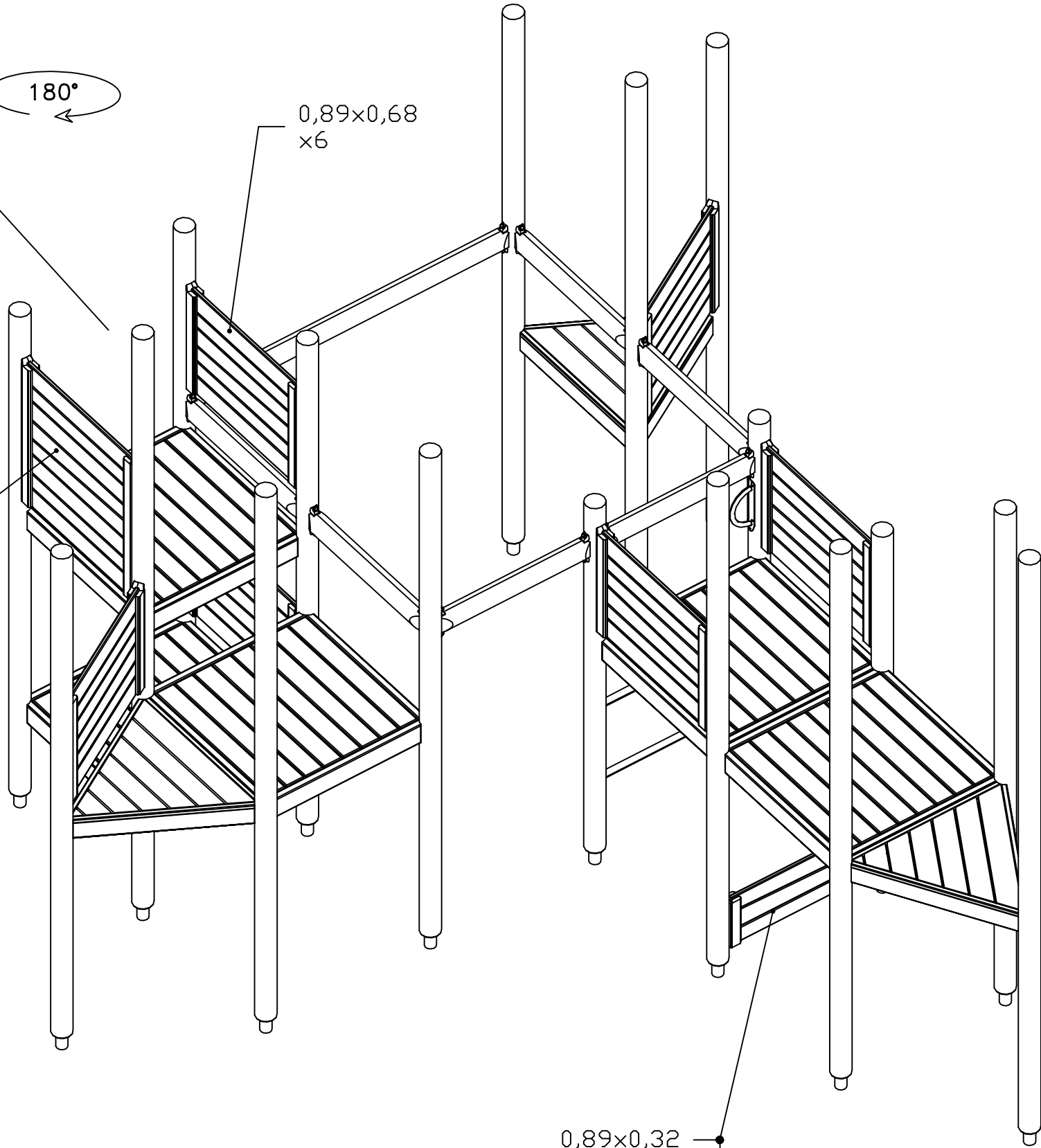

0,89x0,32

426200

**HAGS** ANEBY, SWEDEN  
+46(0)380-47300  
www.hags.com

UniPlay Brann  
MASW65172  
5/10

LN LN 2019-04-04 1

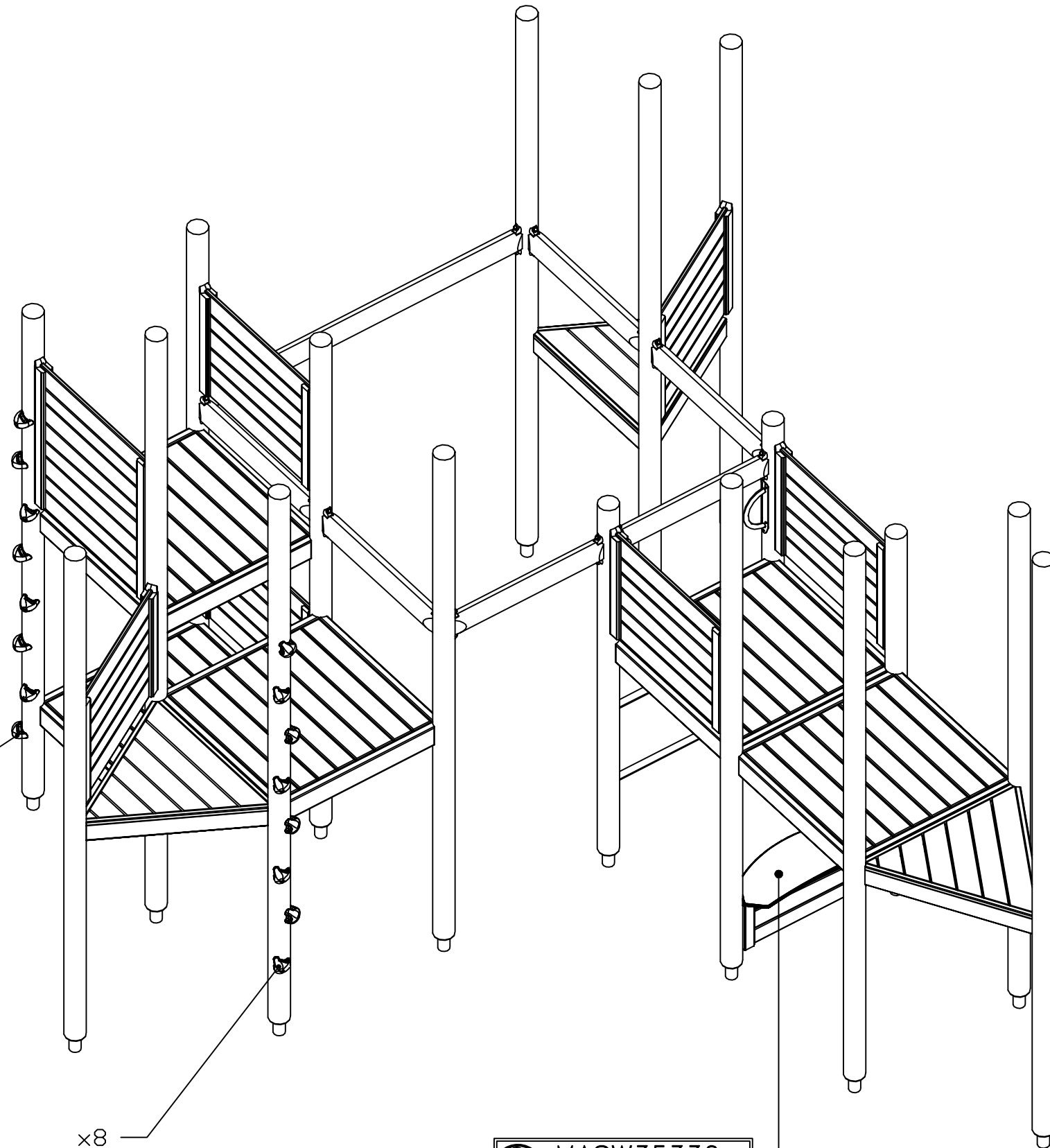
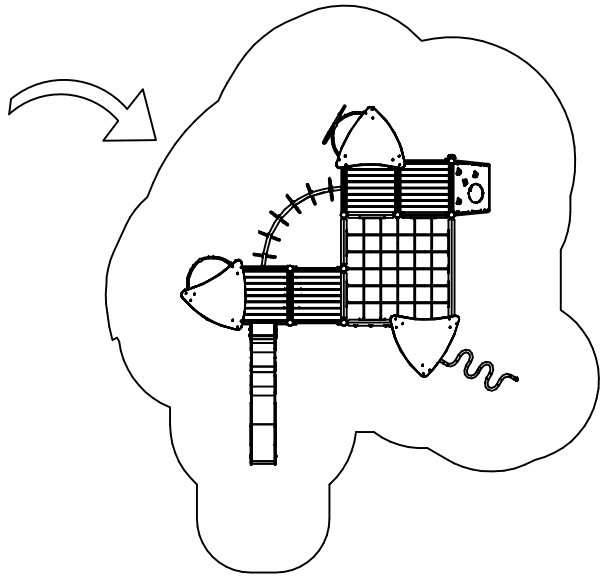

**HAGS** ANEBY, SWEDEN  
+46(0)380-47300  
www.hags.com

UniPlay Brann  
MASW65172  
6/10

LN LN 2019-04-04 1

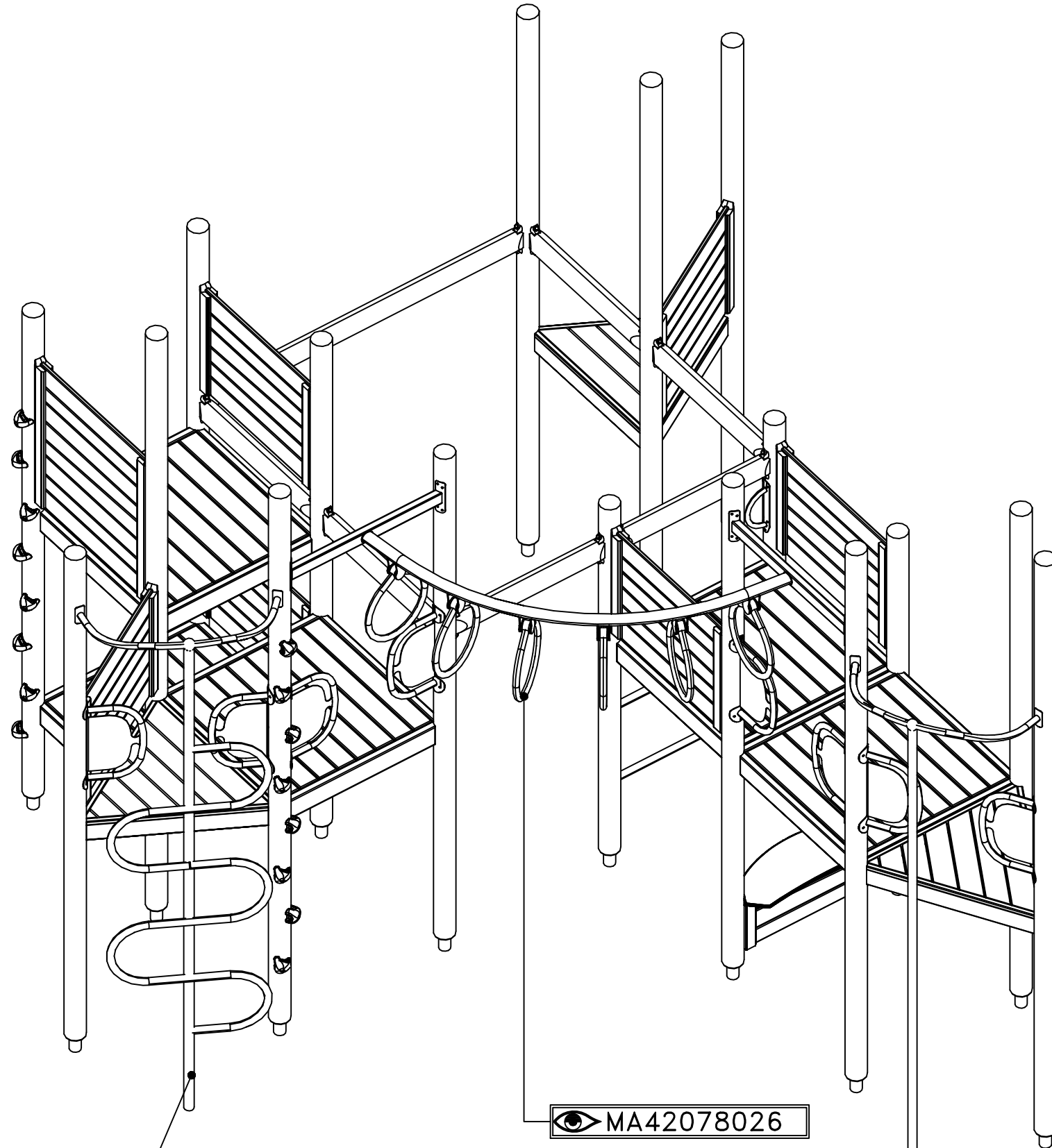
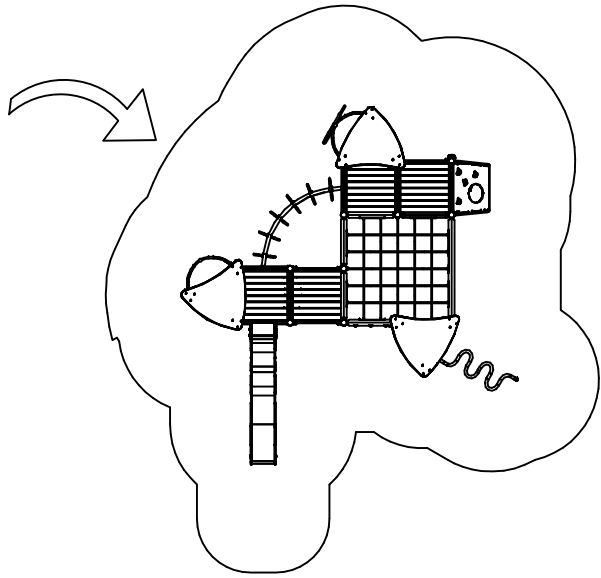

42077130

MA42078026

42077010

**HAGS** ANEBY, SWEDEN  
+46(0)380-47300  
www.hags.com

UniPlay Brann  
MASW65172  
7/10

LN LN 2019-04-04 1



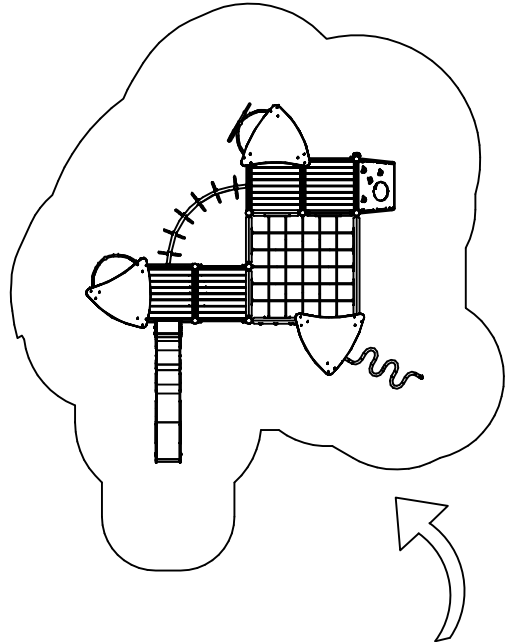

42070711

MASW34935

MASW37501

+0,27

42072610

**HAGS** ANEBY, SWEDEN  
 +46(0)380-47300  
 www.hags.com

UniPlay Brann  
 MASW65172  
 8/10

LN LN 2019-04-04 1

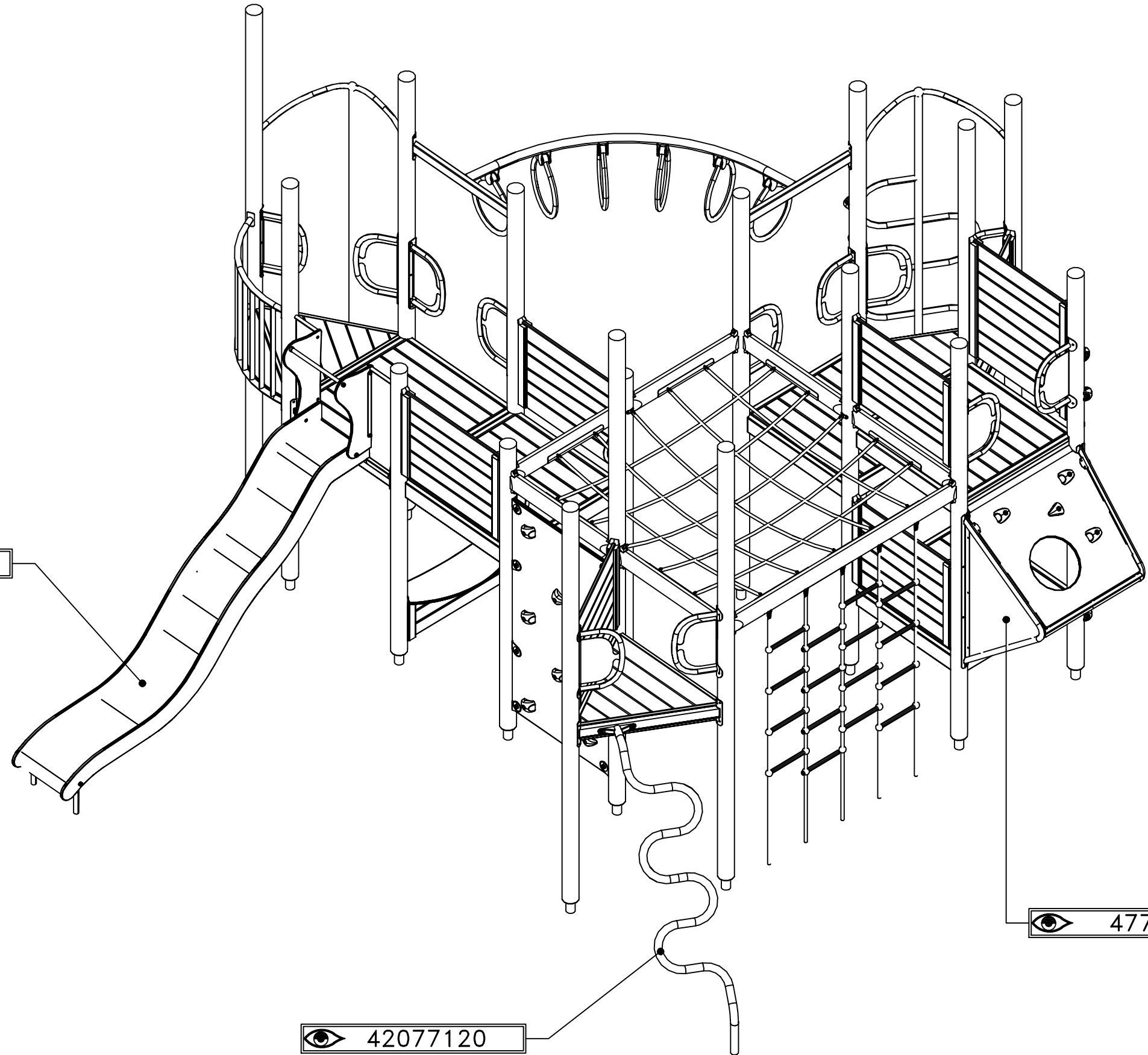
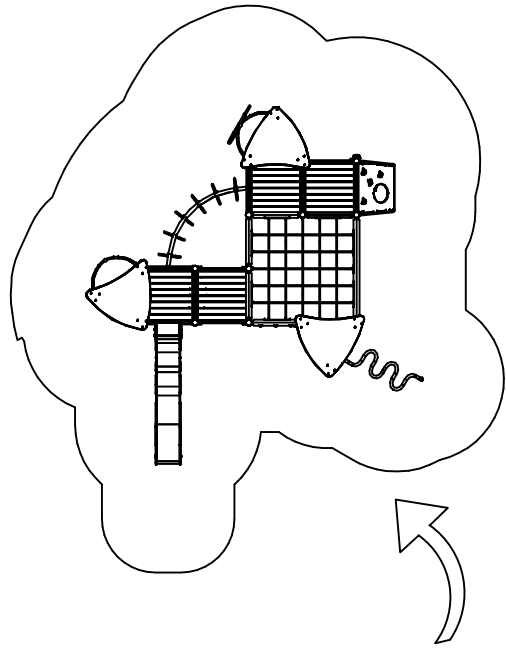

423213

42077120

477212

**HAGS** ANEBY, SWEDEN  
+46(0)380-47300  
www.hags.com

UniPlay Brann  
MASW65172  
9/10

LN LN 2019-04-04 1

# STEP 8

[m]

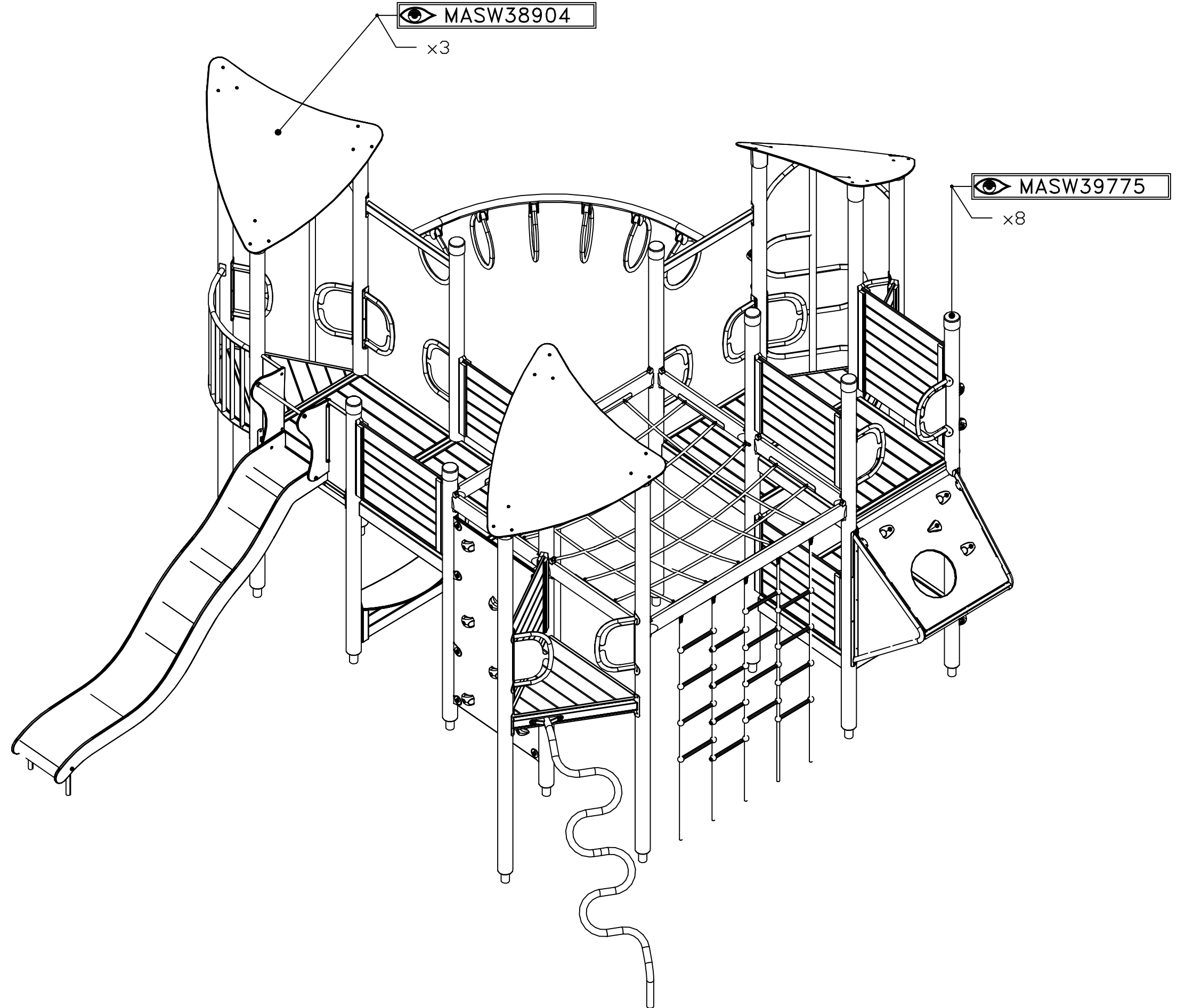
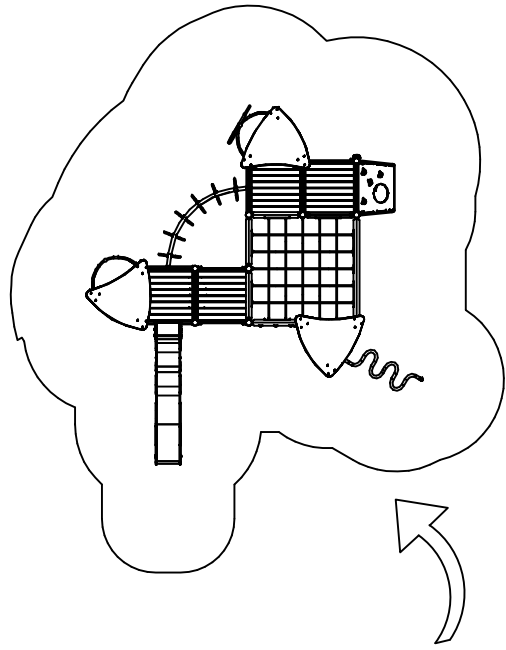

**HAGS** ANEBY, SWEDEN  
+46(0)380-47300  
www.hags.com

UniPlay Brann  
MASW65172  
10/10

LN LN 2019-04-04 1