

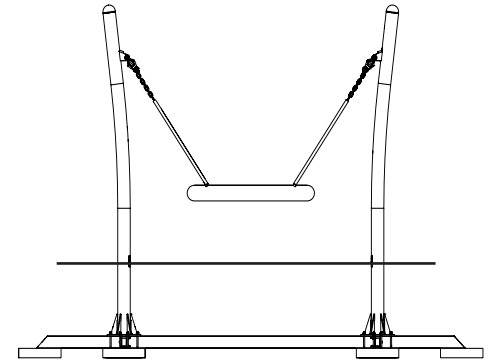















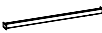

S



1	43-04818		4x	CAP 10, Ø17x14,5 mm	0.01kg
2	43-04820		4x	Cover 10, Ø25x12mm	0.00kg
3	8008796		2x	Lock Nut M10	0.00kg
4	8042810		16x	Nut, ISO7042-M10-8	0.012kg
5	SW20147		2x	1180 x 640 mm	22.98kg
6	SW20172		4x		0.02kg
7	SW42011		6x	300 x 300 x 60 mm	12.42kg
8	SW63877		1x		15.82kg
9	SW65420		1x		23.36kg
10	SW84435		2x		0.94 kg
11	SW86352		2x		25.21 kg
12	8008384		8x	Screw, ISO4014-M10x65-8.8	0.0510kg

13	8008373		6x	Screw, ISO4017-M10x30-8.8	0.0294 kg
14	8050050		29x	Washer ISO7089-10.5x20x2	0.004 kg
15	8071044		4x	Washer ISO7092-10.5x18.1.6	0.002 kg
16	43-04821		2x	Ø10,5x34x4 mm	0.00kg
17	8008383		2x	Screw, ISO4014-M10x60-8.8	0.0479 kg

S19



4

S20



1 x 4

S17



1

