

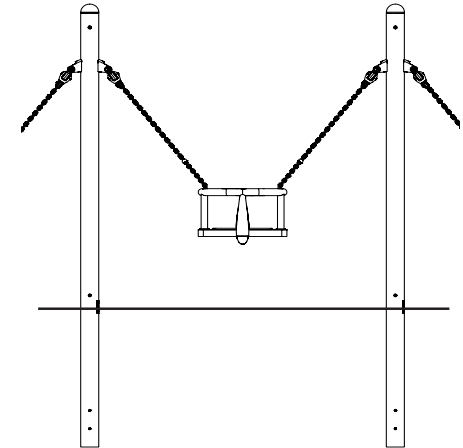











CC



1	43-04818		4x CAP 10, Ø17x14,5 mm	0.01kg
2	43-04820		4x Cover 10, Ø25x12mm	0.00kg
3	8008796		2x Nut, Fujilok-M10-8-RingA2	0.011kg
4	8019919		2x Ø10 x 400 mm	0.00kg
5	SW31746		1x	5.15kg
6	SW75571		1x	25.25kg
7	SW84435		2x	0.93kg
8	8008383		2x Screw, ISO4014-M10x60-8.8	0.0479kg
9	8008502		4x Screw, ISO7380-1-M8x20-10.9	0.011kg
10	8071044		4x Washer ISO7092-10.5x18.1.6	0.002kg
11	43-04821		2x Ø10,5x34x4 mm	0.00kg
12	SW32687		2x	0.83kg



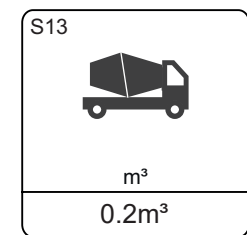
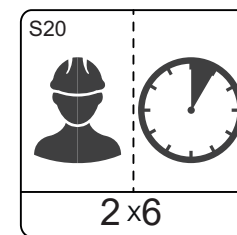
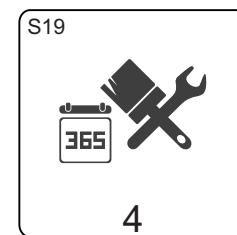
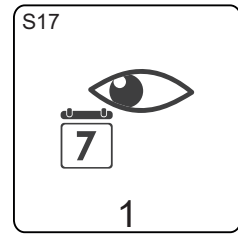
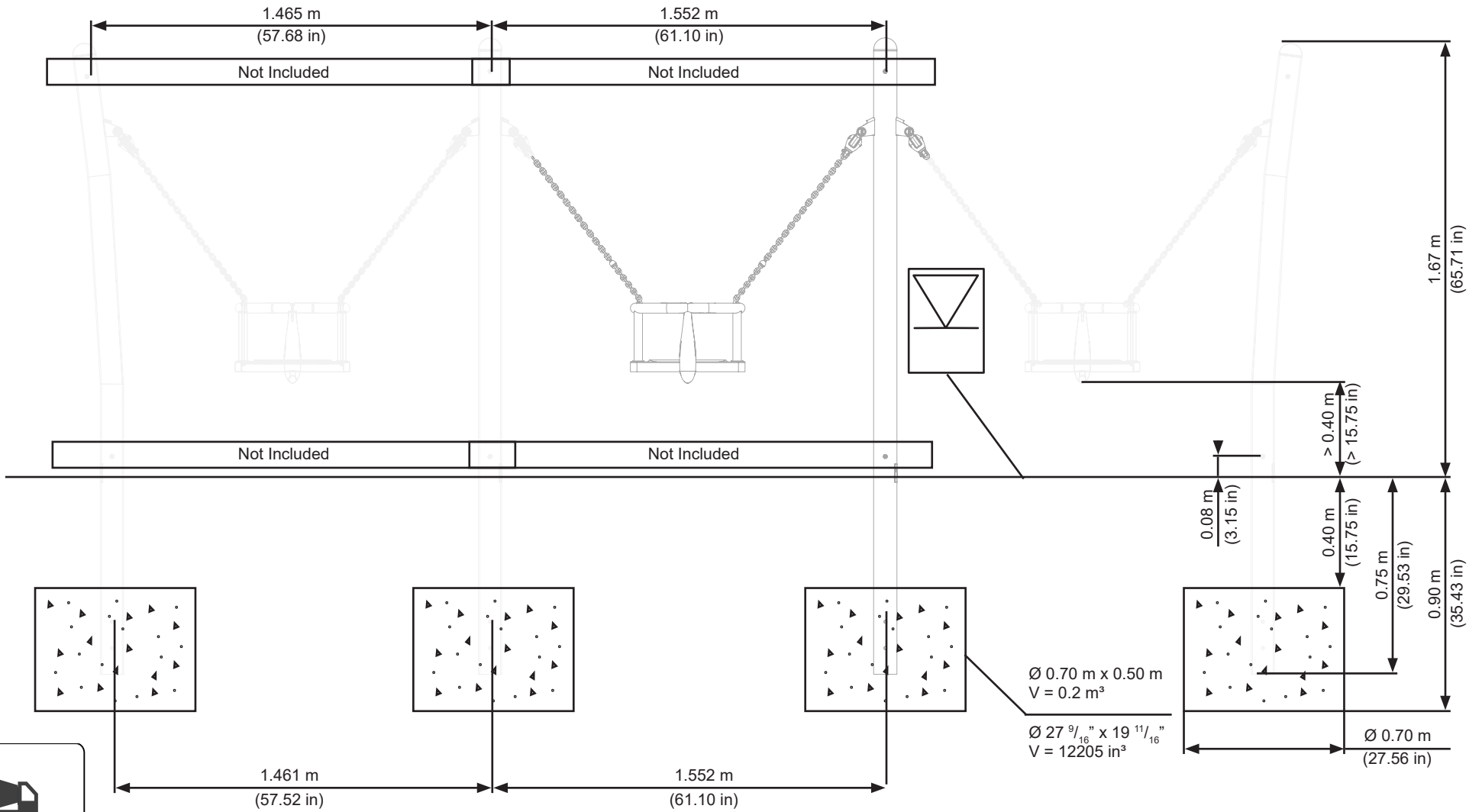

S25	
0.2 m ³	
	7 x 24
	101

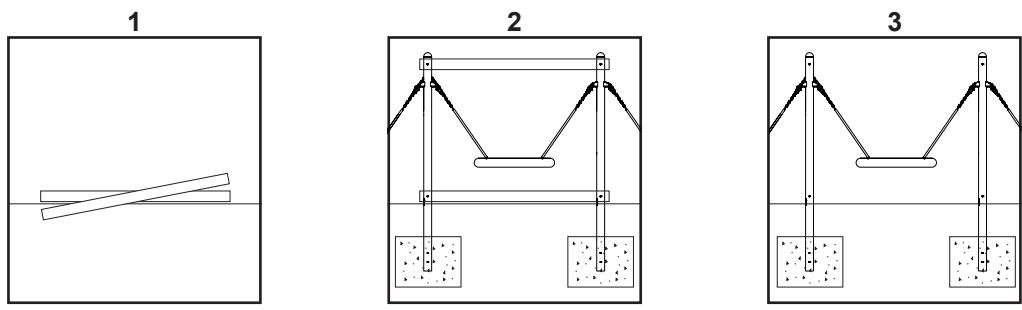

Ø 0.70 m x 0.50 m
V = 0.2 m³
Ø 27 9/16" x 19 11/16"
V = 12205 in³

