

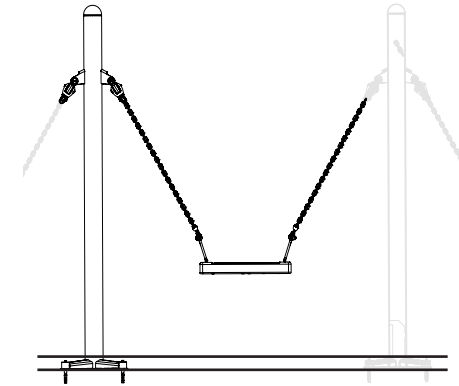











OM



1	43-04818		4x CAP 10, Ø17x14,5 mm	0.01kg
2	43-04820		4x Cover 10, Ø25x12mm	0.00kg
3	8019914		4x Expansion anchor M12x106 HDG	0.08kg
4	8008796		2x Nut, Fujilok-M10-8-RingA2	0.011kg
5	SW84435		2x	0.93kg
6	SW75576		1x	24.08kg
7	SW68067		1x	5.40kg
8	8008383		2x Screw, ISO4014-M10x60-8.8	0.0479kg
9	8071044		4x Washer ISO7092-10.5x18.1.6	0.002kg
10	43-04821		2x Ø10,5x34x4 mm	0.00kg

