

42008010

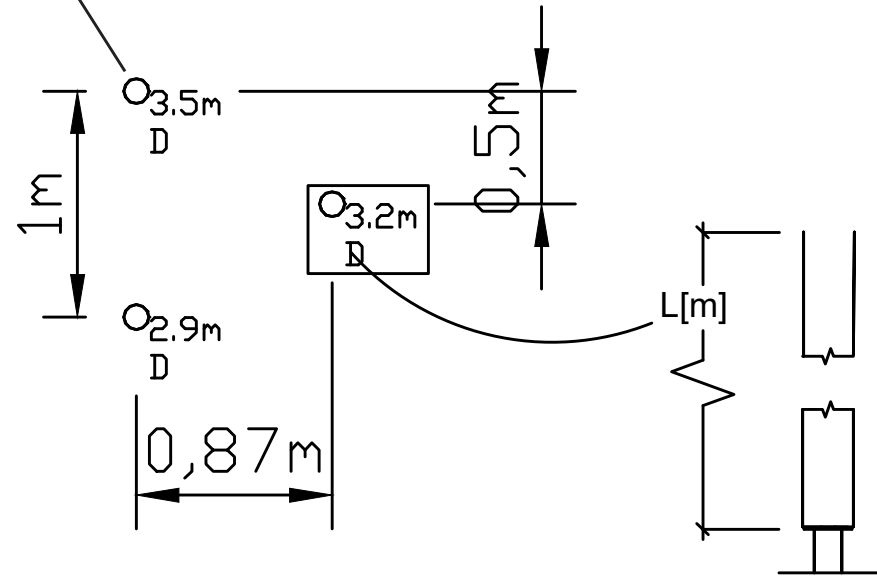

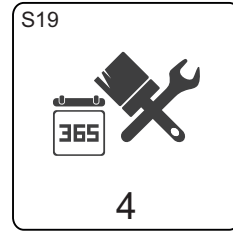
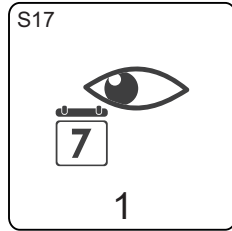
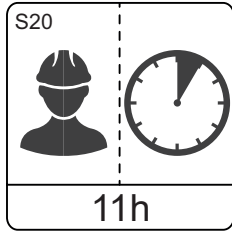
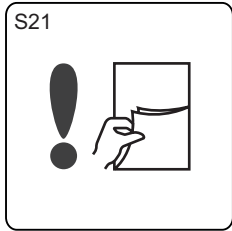

**260329**  
**441000**  
**42008010**  
**MA45060520**  
**MA45077010 [SF]**  
**MA450994**  
**MA452213 [OM]**  
**MA45277010 [OM]**  
**MA453213 [SF]**  
**MA454213 [BM]**  
**MA45477010 [BM]**  
**MASW38904**  
**MASW53817**

42008010

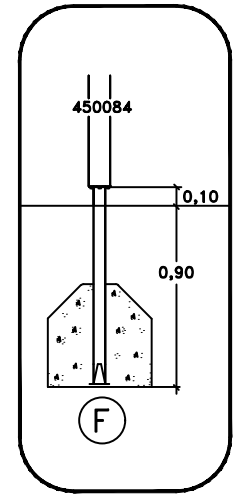
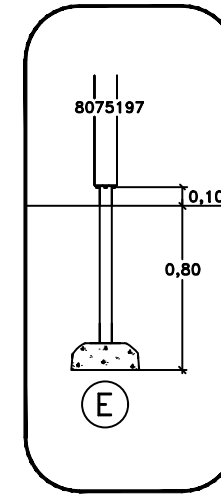
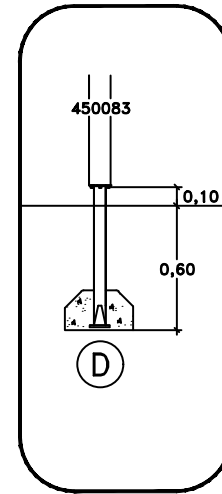
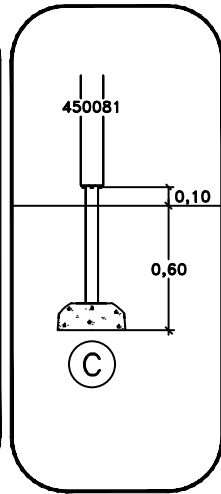
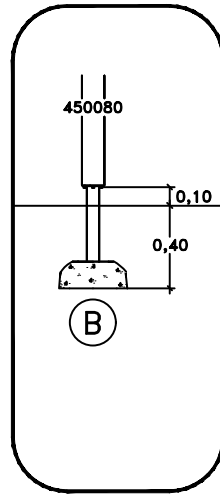
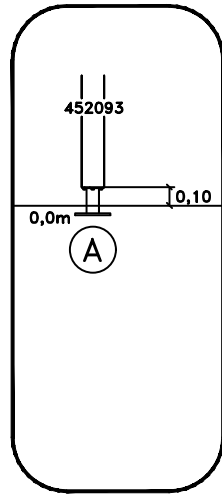

**OM**  
**Above Ground**

8105792  
80 \_\_\_\_\_  
80 \_\_\_\_\_  
80 \_\_\_\_\_  
80 \_\_\_\_\_

**SF**  
**Sunken Foundation**

8105791  
80 \_\_\_\_\_  
80 \_\_\_\_\_  
80 \_\_\_\_\_  
80 \_\_\_\_\_

**CC**  
**Cast In Place**

8077977  
8105793  
80 \_\_\_\_\_  
80 \_\_\_\_\_

**BM**  
**Loosefill**

80 \_\_\_\_\_  
80 \_\_\_\_\_  
80 \_\_\_\_\_  
80 \_\_\_\_\_

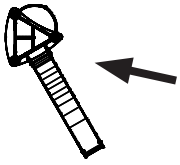

441000  
x3

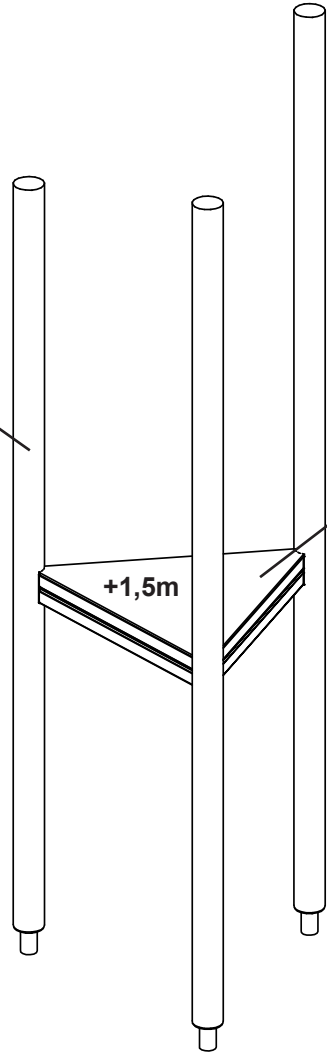

MASW53817

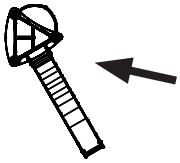

- MA453213 [SF]
- MA454213 [BM]
- MA452213 [OM]

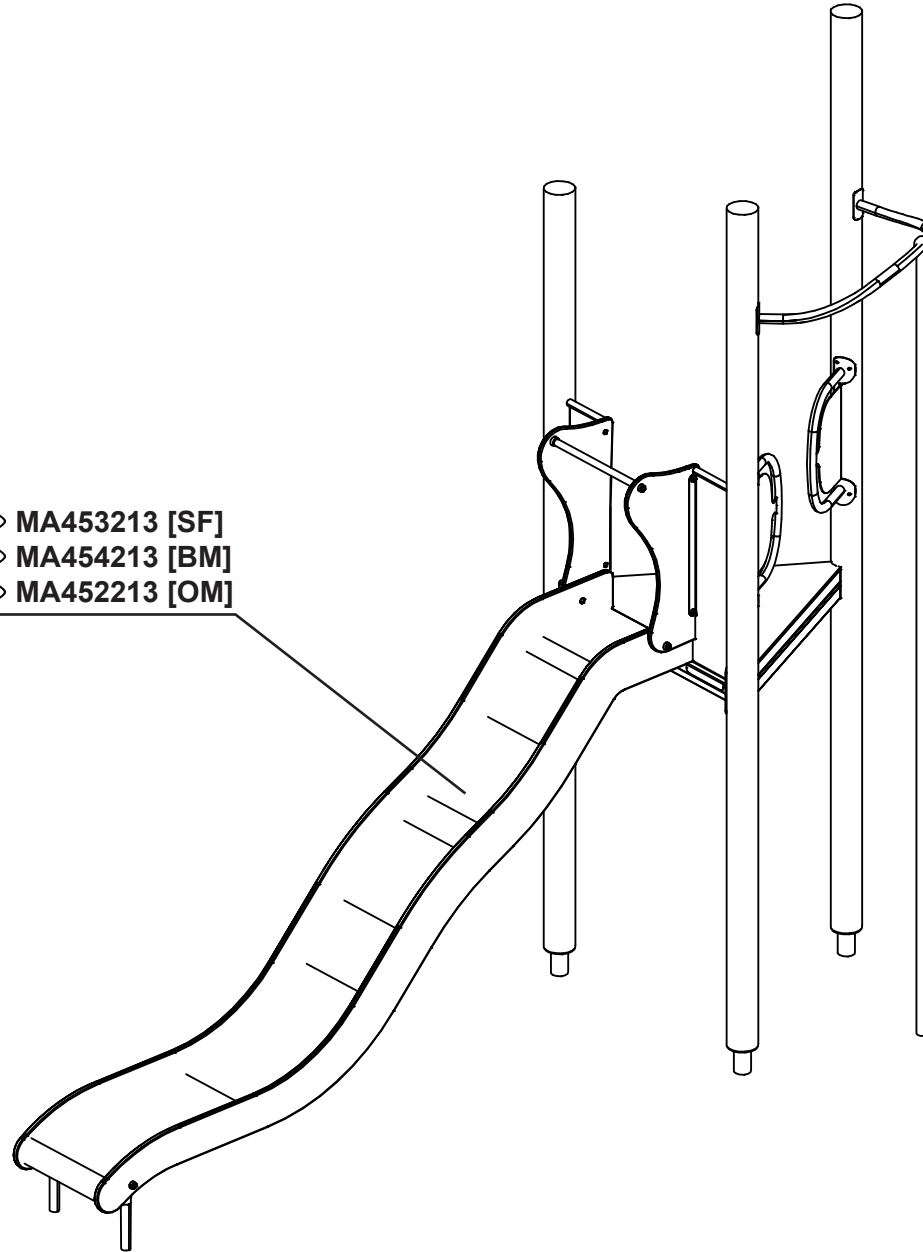

- MA45077010 [SF]
- MA45477010 [BM]
- MA45277010 [OM]

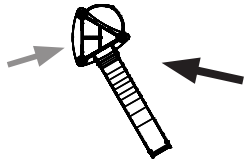

MA450994  
x2

+1,00m

+0,60m

MA45060520  
x2

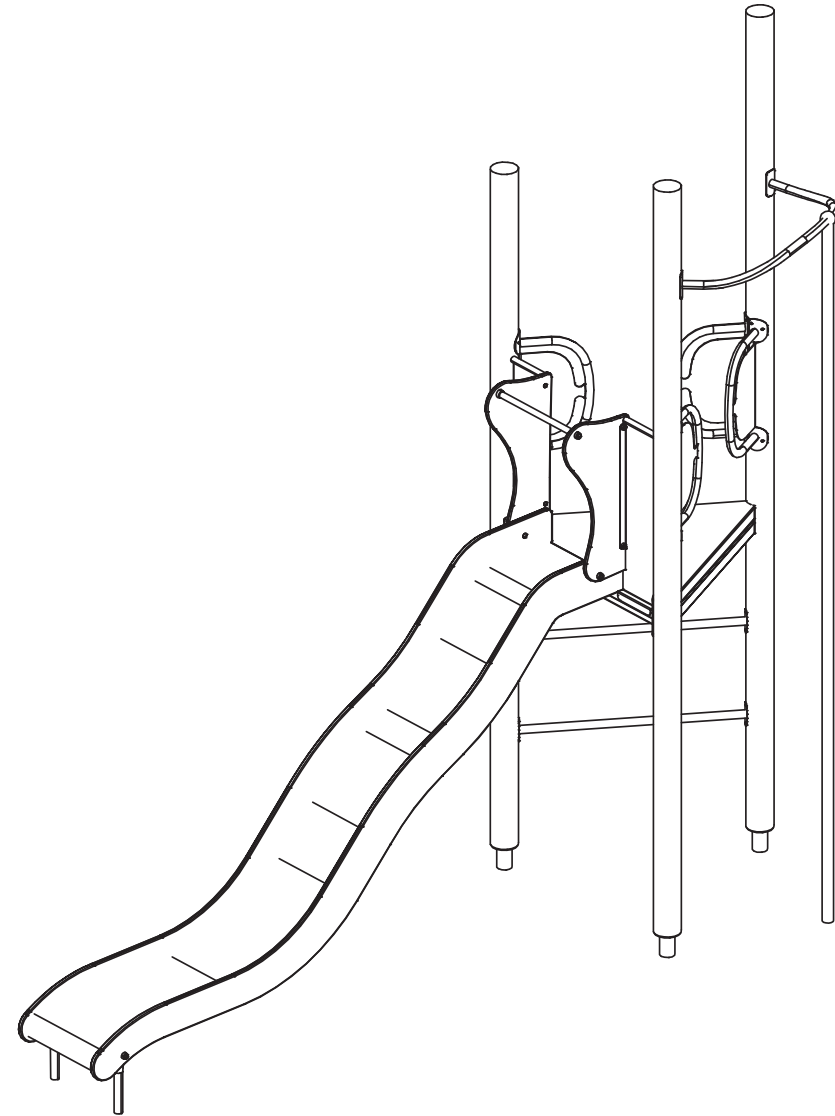

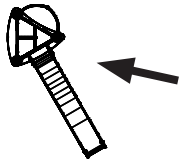

 MASW38904

 260329

