

(1/40)

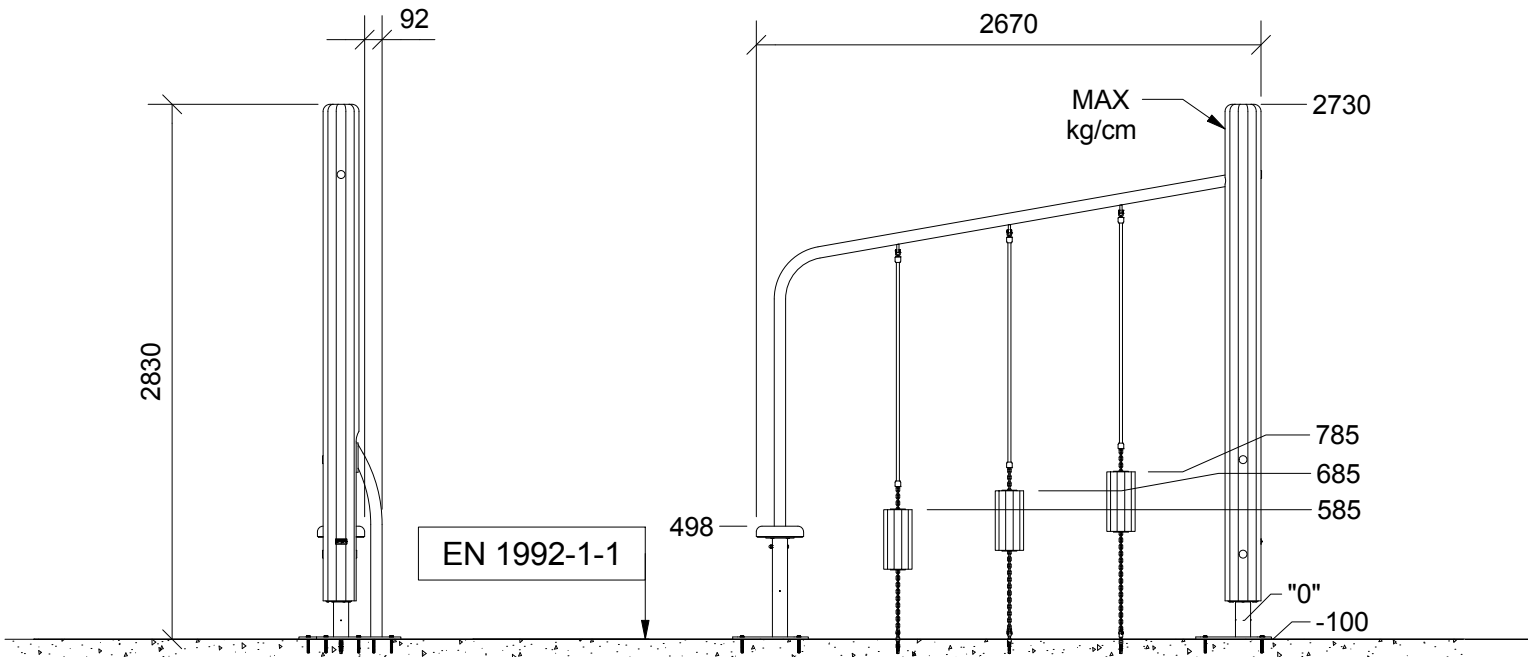

(1/40)

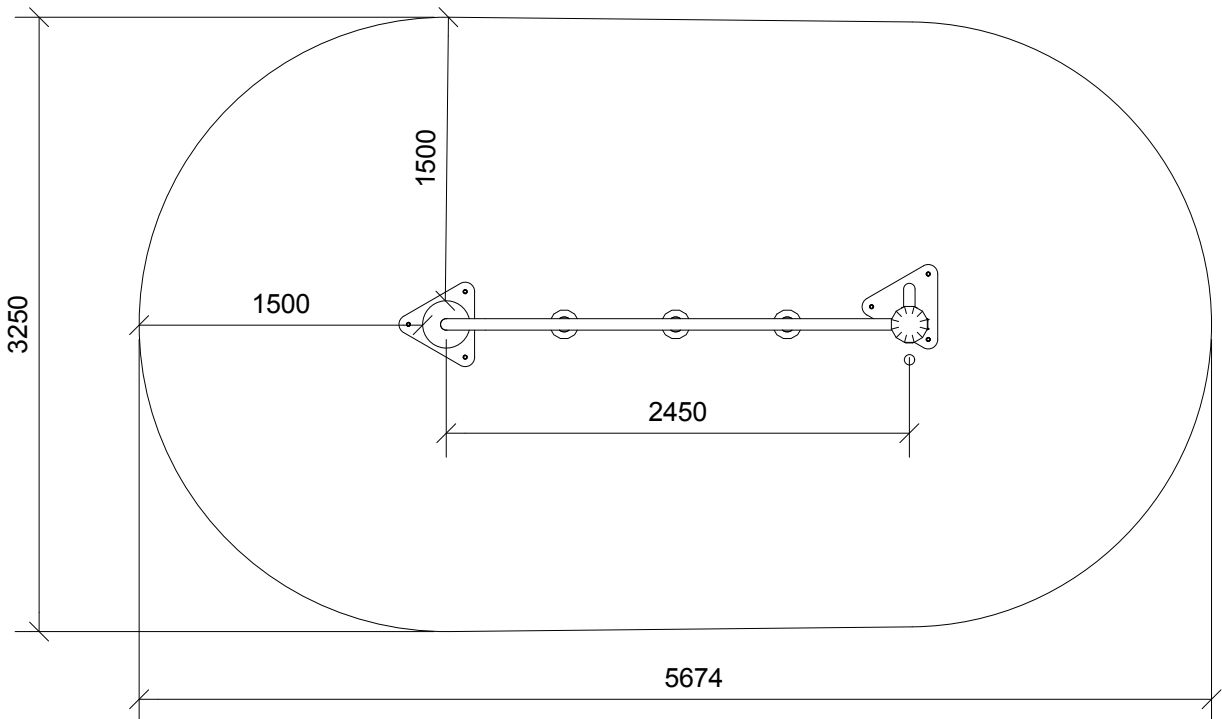

2



4,5h



16,5m²



5,7x3,3x2,9m



~140 kg



85x285



90kg

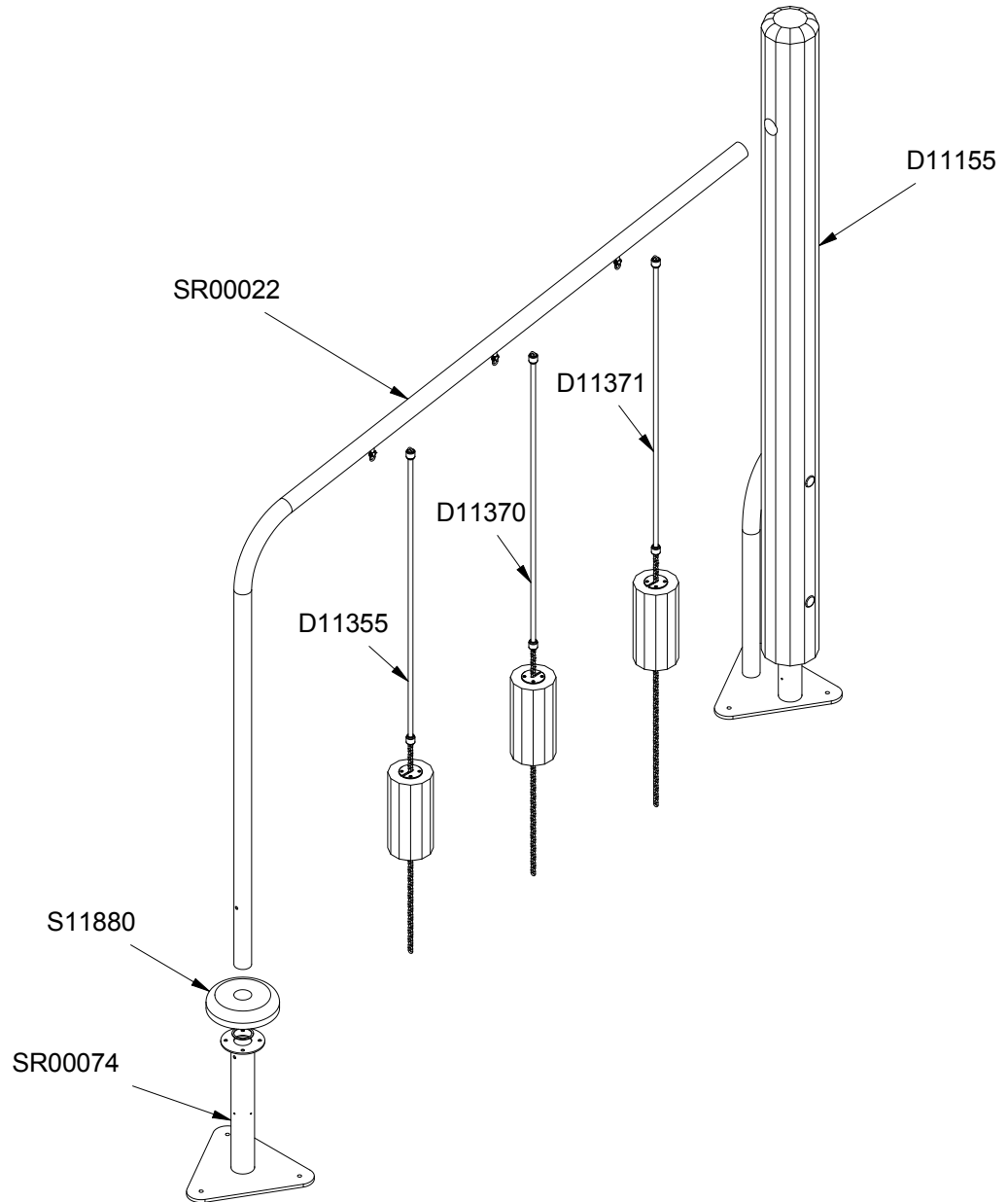

Parts List		
QTY	PART NO	DESCRIP.
1	D11155	45x283 cm, assembled
1	D11355	Block/chain 70 cm
1	D11370	Block/chain 80 cm
1	D11371	Block/chain 90 cm
1	S11880	Ø250/45 mm
1	SR00022	Ø60x3 Tube
1	SR00074	450x540mm

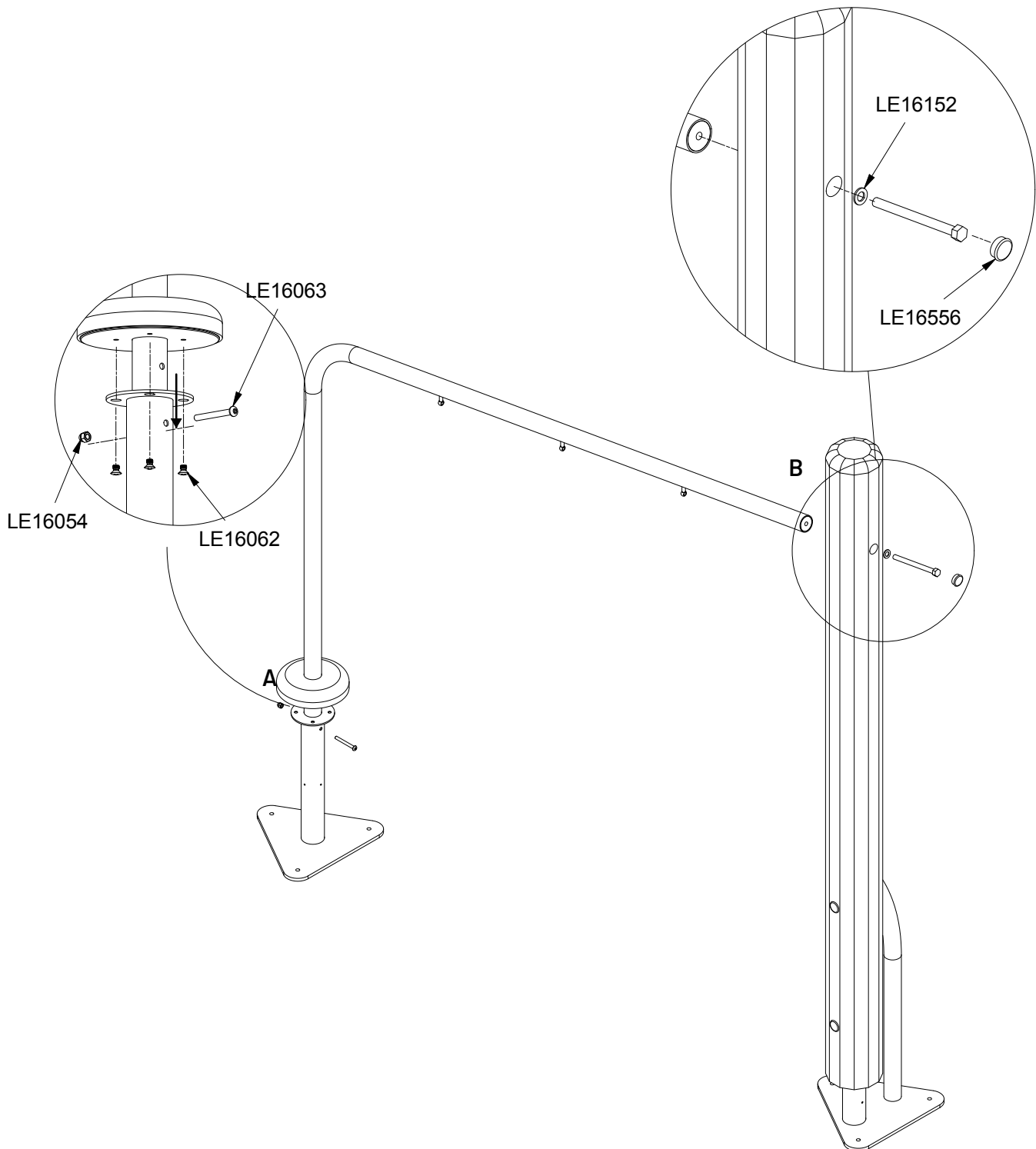

Parts List

QTY	PART NO	DESCRIP.
1	LE15252	M16x200 mm
1	LE16054	M10 cap nut
4	LE16062	10x16 mm
1	LE16063	10x90 mm
1	LE16152	M16 - Ø30 mm
1	LE16556	Ø42/38mm

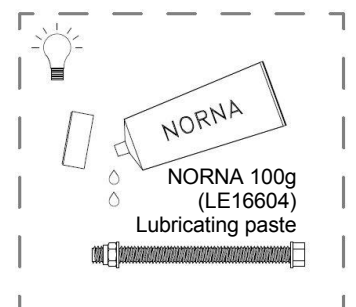

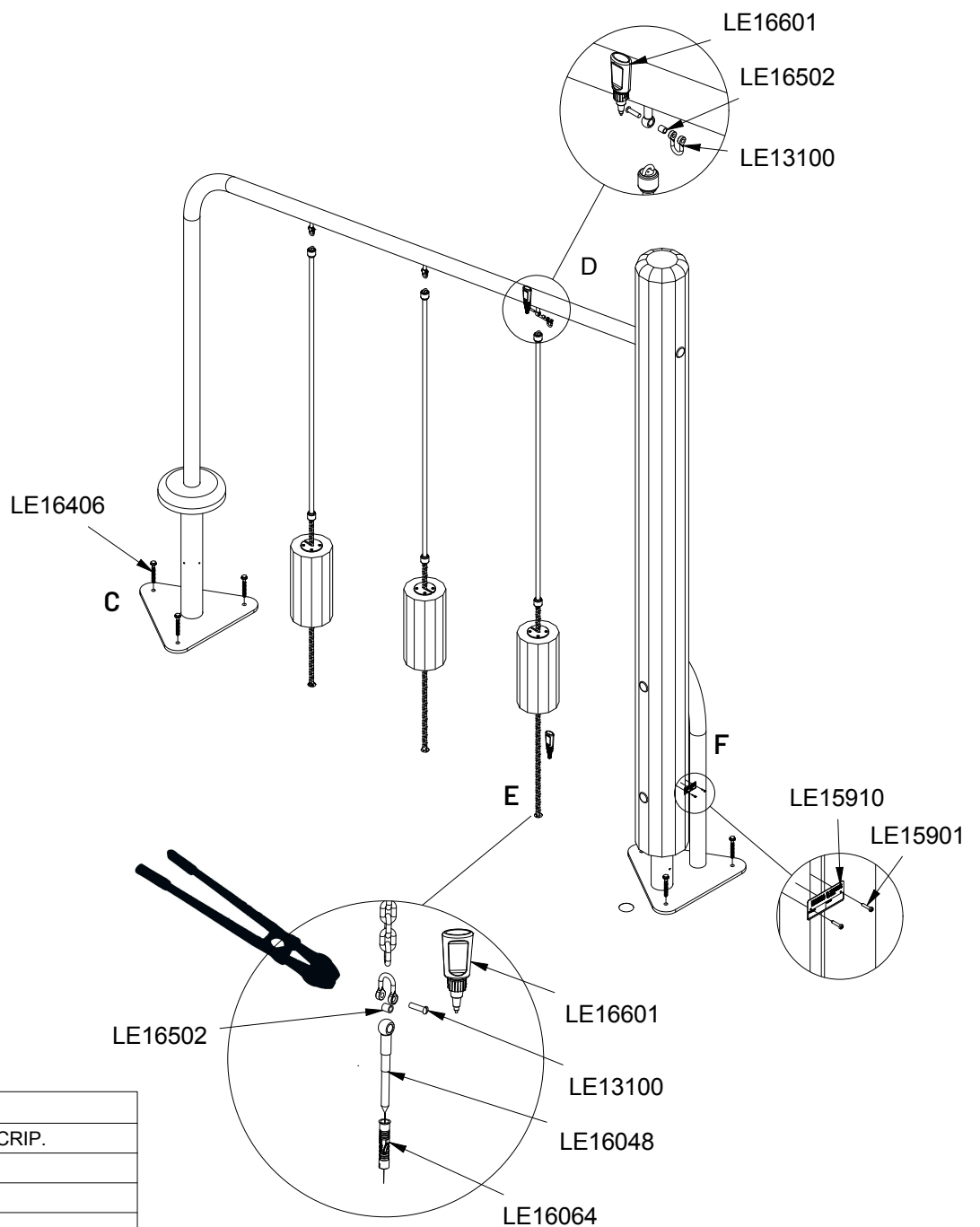
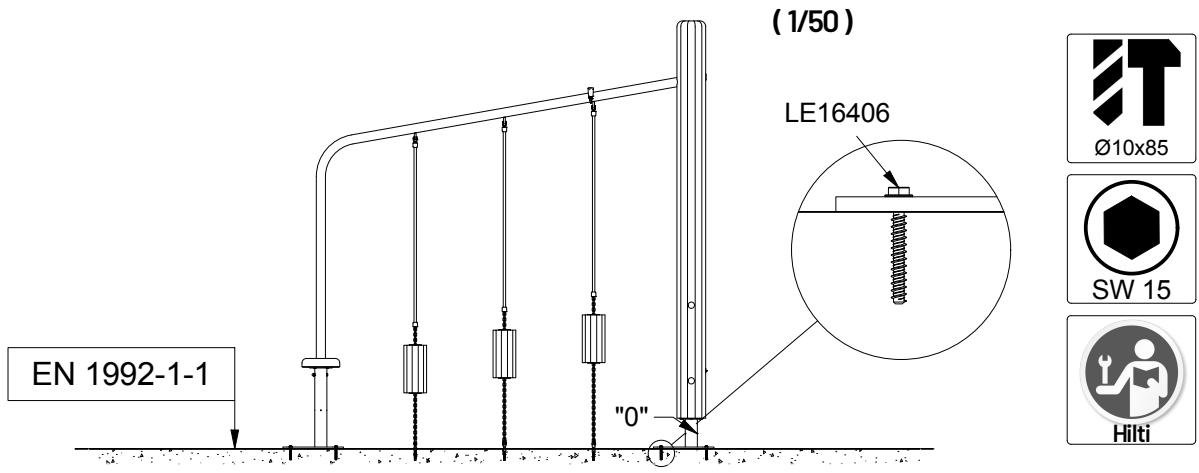

Parts List		
QTY	PART NO	DESCRIP.
1	LE15252	M16x200 mm
1	LE16054	M10 cap nut
4	LE16062	10x16 mm
1	LE16063	10x90 mm
1	LE16152	M16 - Ø30 mm
1	LE16556	Ø42/38mm