

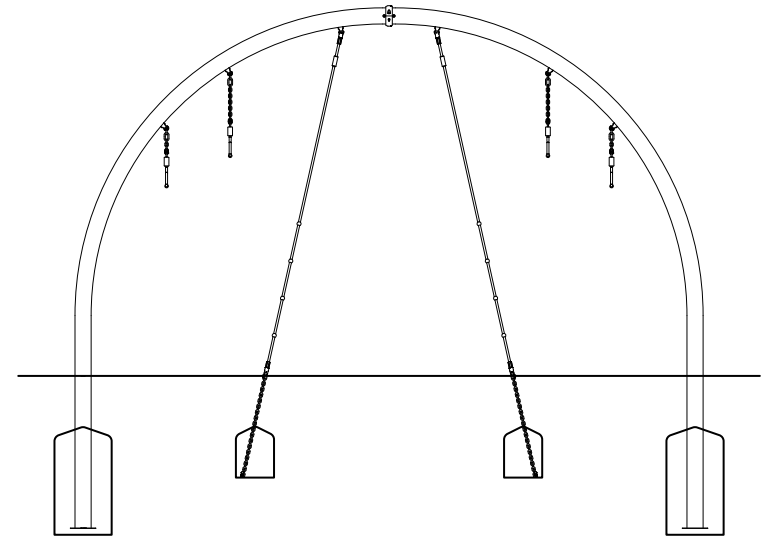









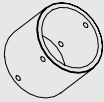
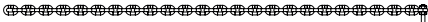





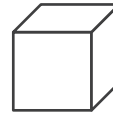

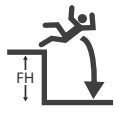

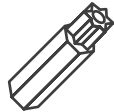

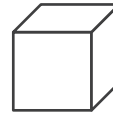

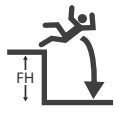

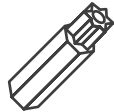

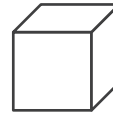

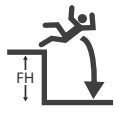

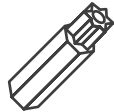
CC & BM

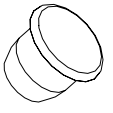

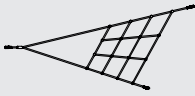
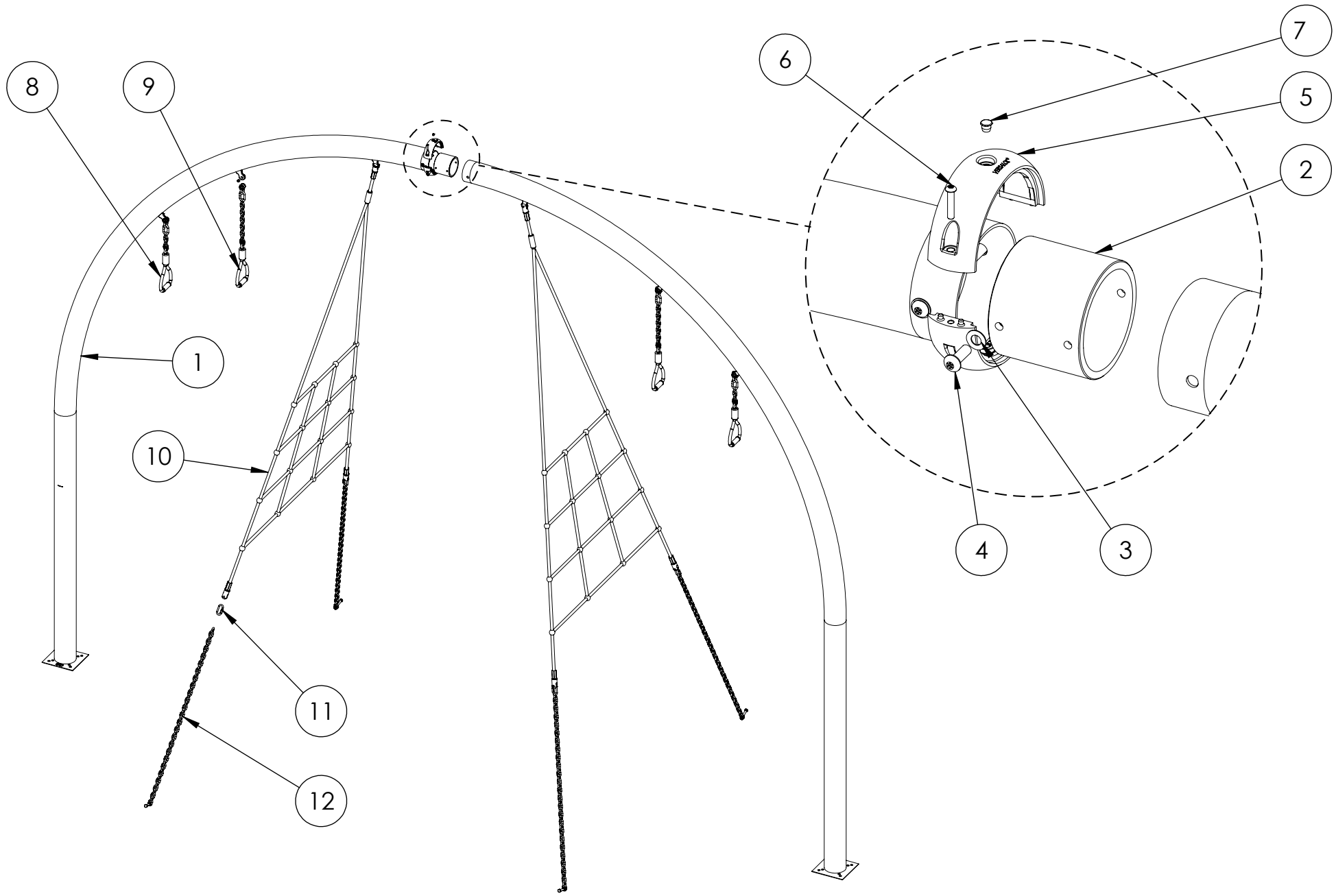
1	78603012		4800x 1310 x 200mm	x2	51Kg	11	109309		Ø7 x 69 x 34 x 11mm	x4	0.06Kg																												
2	78604001		Ø118 x 100mm	x1	2.2g	12	78804031		Ø8 x 1150mm	x4	1.70Kg																												
3	10291000		M10_B_Ø11 x Ø21 x 1_A2	x4	0.002Kg	13	950040			x1																													
4	10121030		M10 x 30_A2_TX45	x4	0.03Kg	14	78804031			x1																													
5	78804306		5" - 163 x 84 x 51	x2	0.27Kg	<table border="1"> <tr> <td>S12</td> <td></td> <td>kg</td> <td>125</td> </tr> <tr> <td>S15</td> <td></td> <td>L x W x H (m)</td> <td>4.94 x 1.53 x 2.91</td> </tr> <tr> <td>S13</td> <td></td> <td>m³</td> <td>0.55</td> </tr> <tr> <td>S14</td> <td></td> <td>m²</td> <td>10 x 10</td> </tr> <tr> <td>S6</td> <td></td> <td>EN1176</td> <td>1.75m</td> </tr> <tr> <td>S20</td> <td></td> <td></td> <td>2 x 6</td> </tr> <tr> <td>S24</td> <td></td> <td></td> <td>10121000 - TX45</td> </tr> </table>						S12		kg	125	S15		L x W x H (m)	4.94 x 1.53 x 2.91	S13		m ³	0.55	S14		m ²	10 x 10	S6		EN1176	1.75m	S20			2 x 6	S24			10121000 - TX45
S12		kg	125																																				
S15		L x W x H (m)	4.94 x 1.53 x 2.91																																				
S13		m ³	0.55																																				
S14		m ²	10 x 10																																				
S6		EN1176	1.75m																																				
S20			2 x 6																																				
S24			10121000 - TX45																																				
6	14104749		1/4" UNC x 1-1/4"	x2	0.01Kg																																		
7	19055030		Ø11.5 x 9.5	x2	0.001Kg																																		
8	78801012		140 x 38 x 456mm	x2	0.60Kg																																		
9	78801011		140 x 38 x 647mm	x2	0.82Kg																																		
10	78805050		Ø16 x 2740 x 1500mm	x2	5.2Kg																																		



S25	
S2 (50mm)	
≥C20-25	
 7 x 24h	
 101	
S13	
m ³	
0.55	

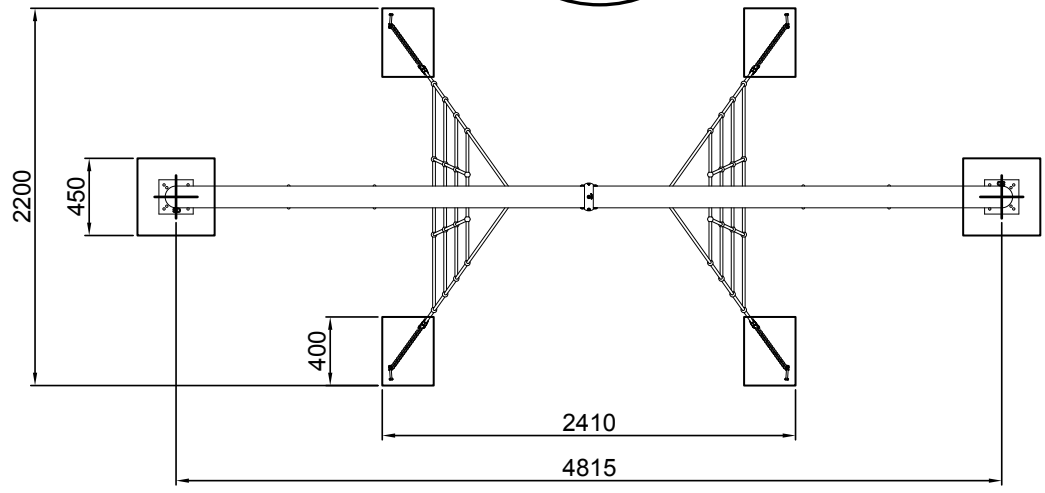
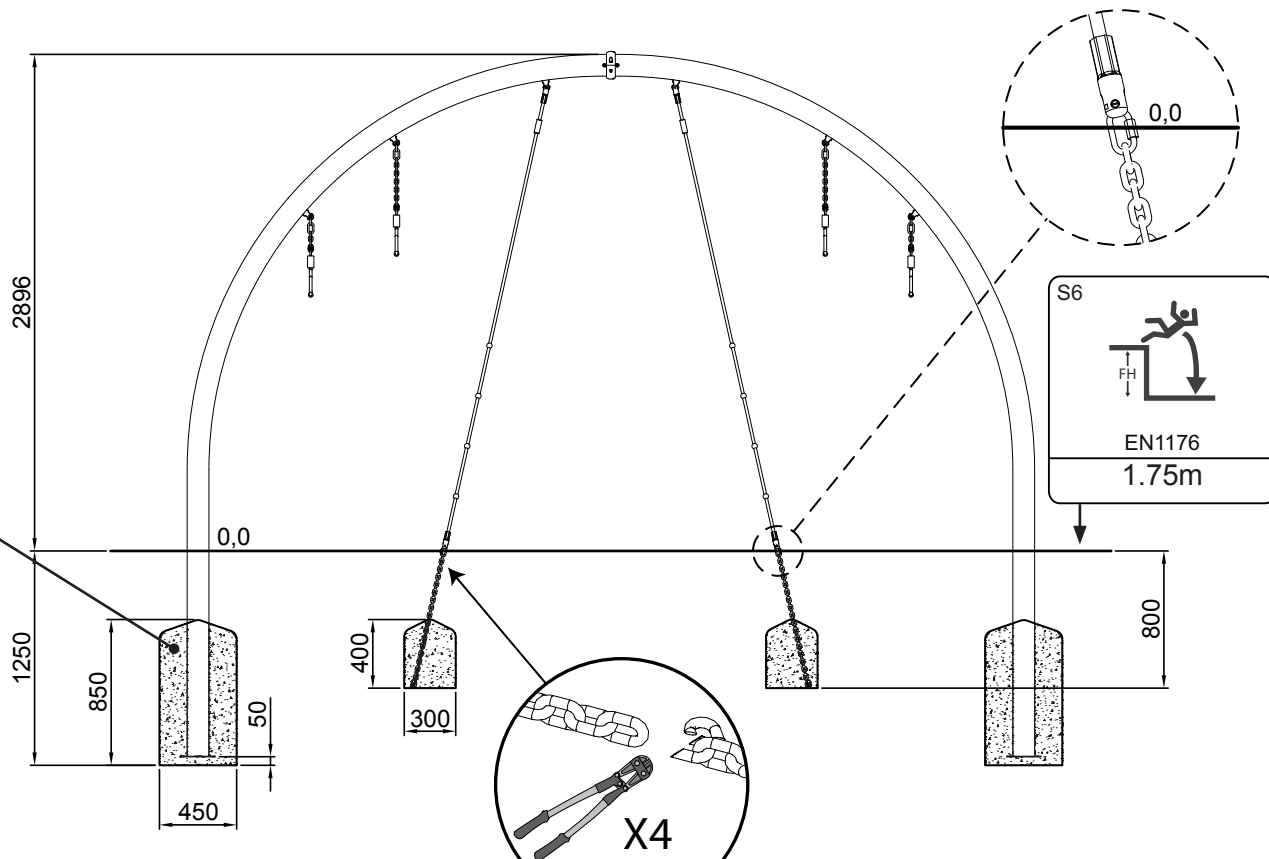

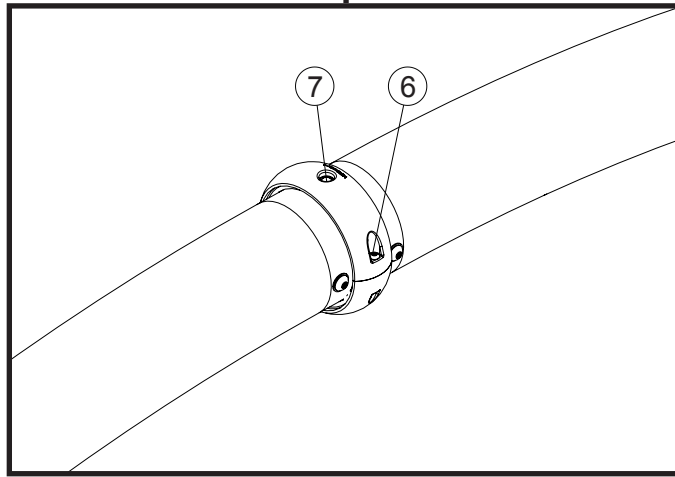
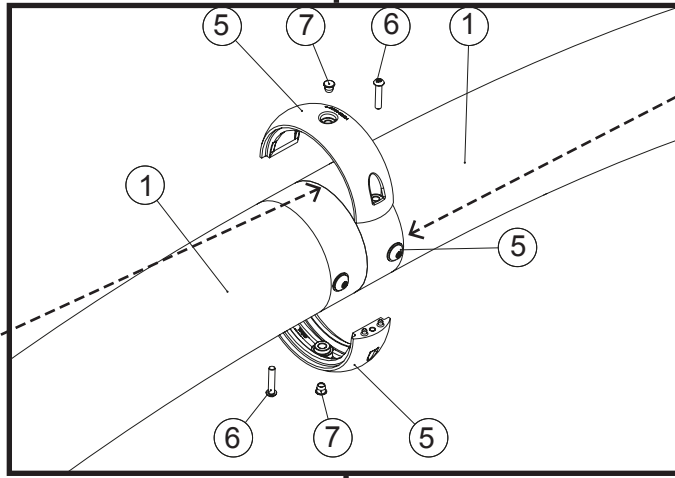
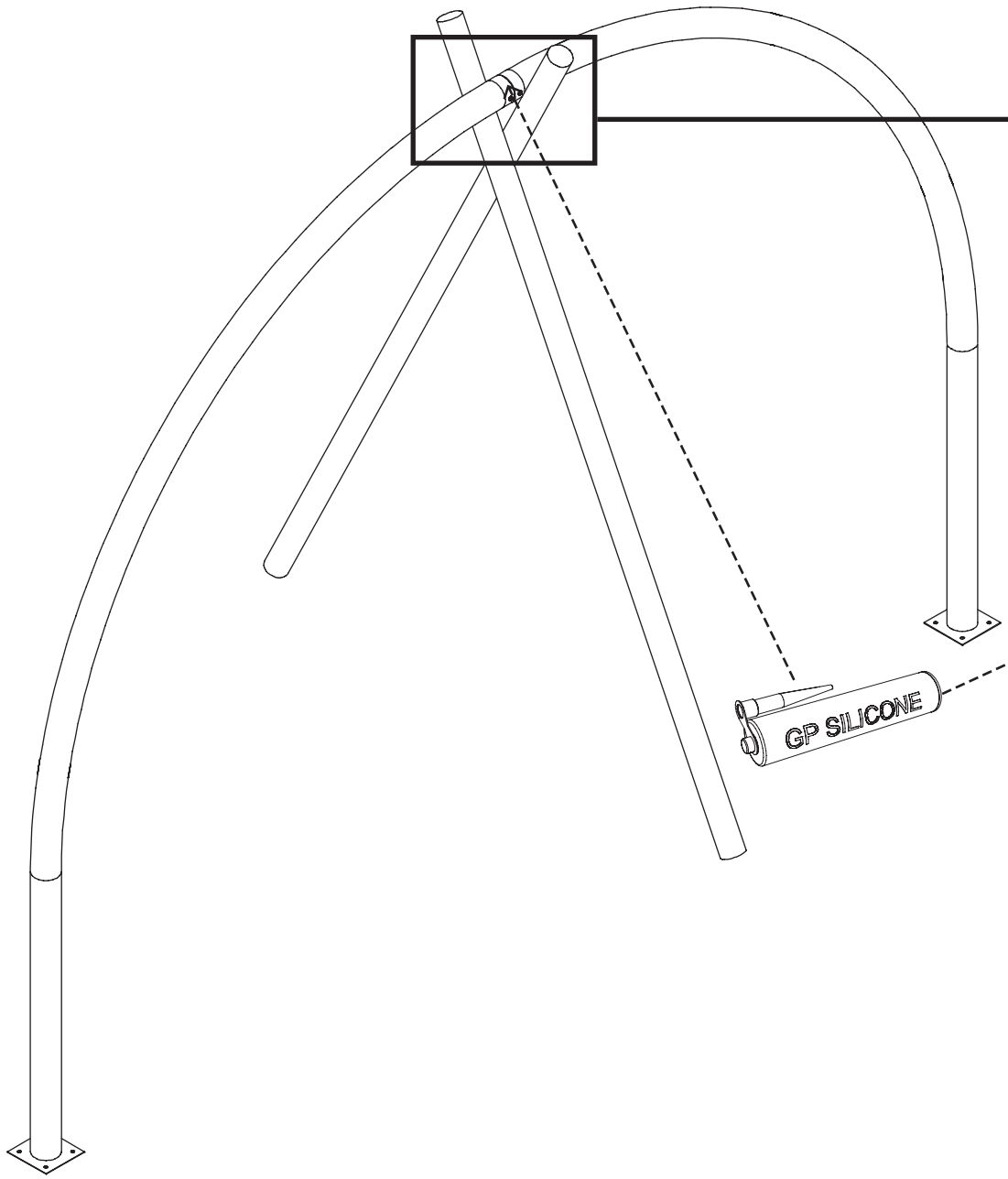

S11



Nm
20-25

