

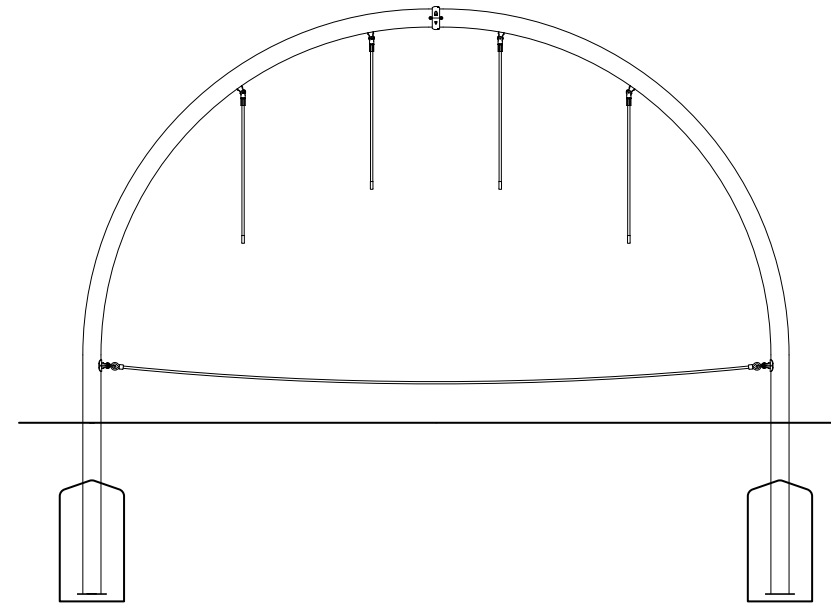









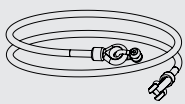
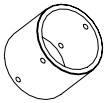

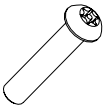
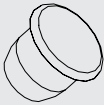

CC & BM

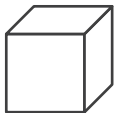

1	78603013		x2	51Kg	4800x 1310 x 200mm
2	78805061		x1	12kg	Ø16 x 4580mm
3	78604001		x1	2.2g	Ø118 x 100mm
4	10291000		x4	0.002Kg	M10_B_Ø11 x Ø21 x 1_A2
5	10121030		x4	0.03Kg	M10 x 30_A2_TX45
6	78804306		x2	0.27Kg	5" - 163 x 84 x 51
7	14104749		x2	0.01Kg	1/4" UNC x 1-1/4"
8	19055030		x2	0.001Kg	Ø11.5 x 9.5
9	78805025		x4	0.25Kg	Ø16 x 1050mm
10	78804031		x1		

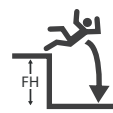
<p>S12</p>  <p>kg</p> <p>116</p>	<p>S15</p>  <p>L x W x H (m)</p> <p>4.94 x 0.13 x 2.91</p>	<p>S13</p>  <p>m³</p> <p>0.35</p>	<p>S14</p>  <p>m²</p> <p>10 x 10</p>
<p>S6</p>  <p>EN1176</p> <p>0.6m</p>	<p>S20</p>  <p>2 x 6</p>	<p>S24</p>  <p>10121000 - TX45</p>	

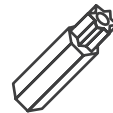
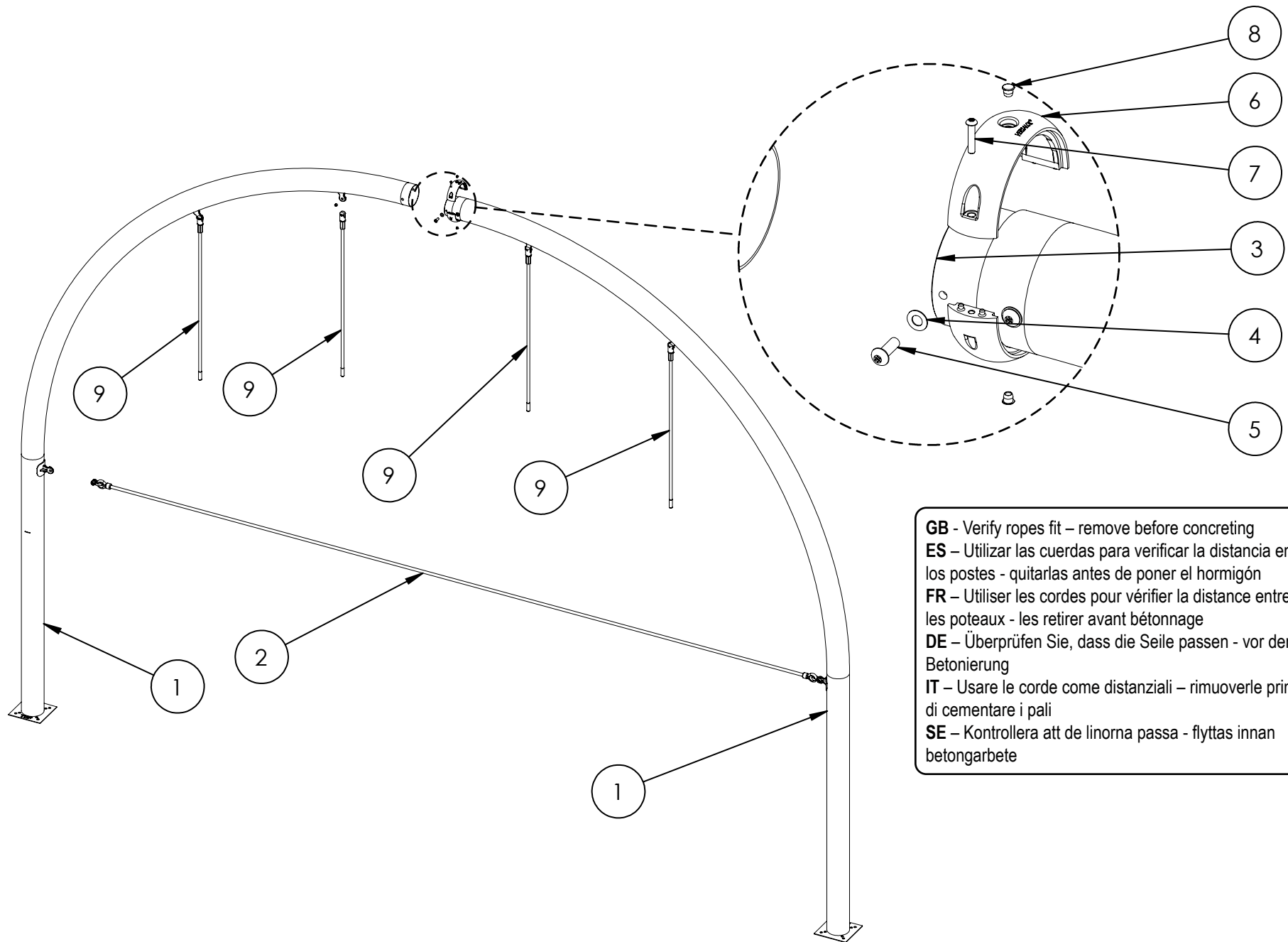



GB - Verify ropes fit – remove before concreting
ES – Utilizar las cuerdas para verificar la distancia entre los postes - quitarlas antes de poner el hormigón
FR – Utiliser les cordes pour vérifier la distance entre les poteaux - les retirer avant bétonnage
DE – Überprüfen Sie, dass die Seile passen - vor der Betonierung
IT – Usare le corde come distanziali – rimuoverle prima di cementare i pali
SE – Kontrollera att de linorna passa - flyttas innan betongarbete

S25



S2 (50mm)
≥C20-25

 7 x 24h

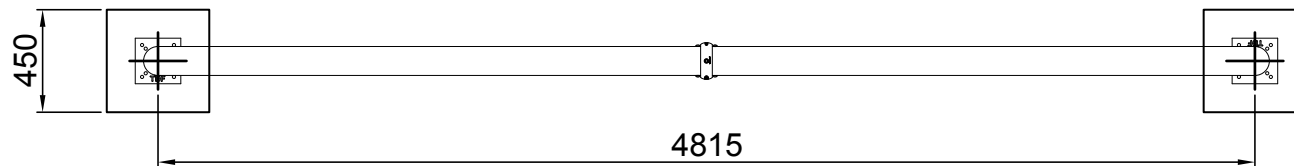
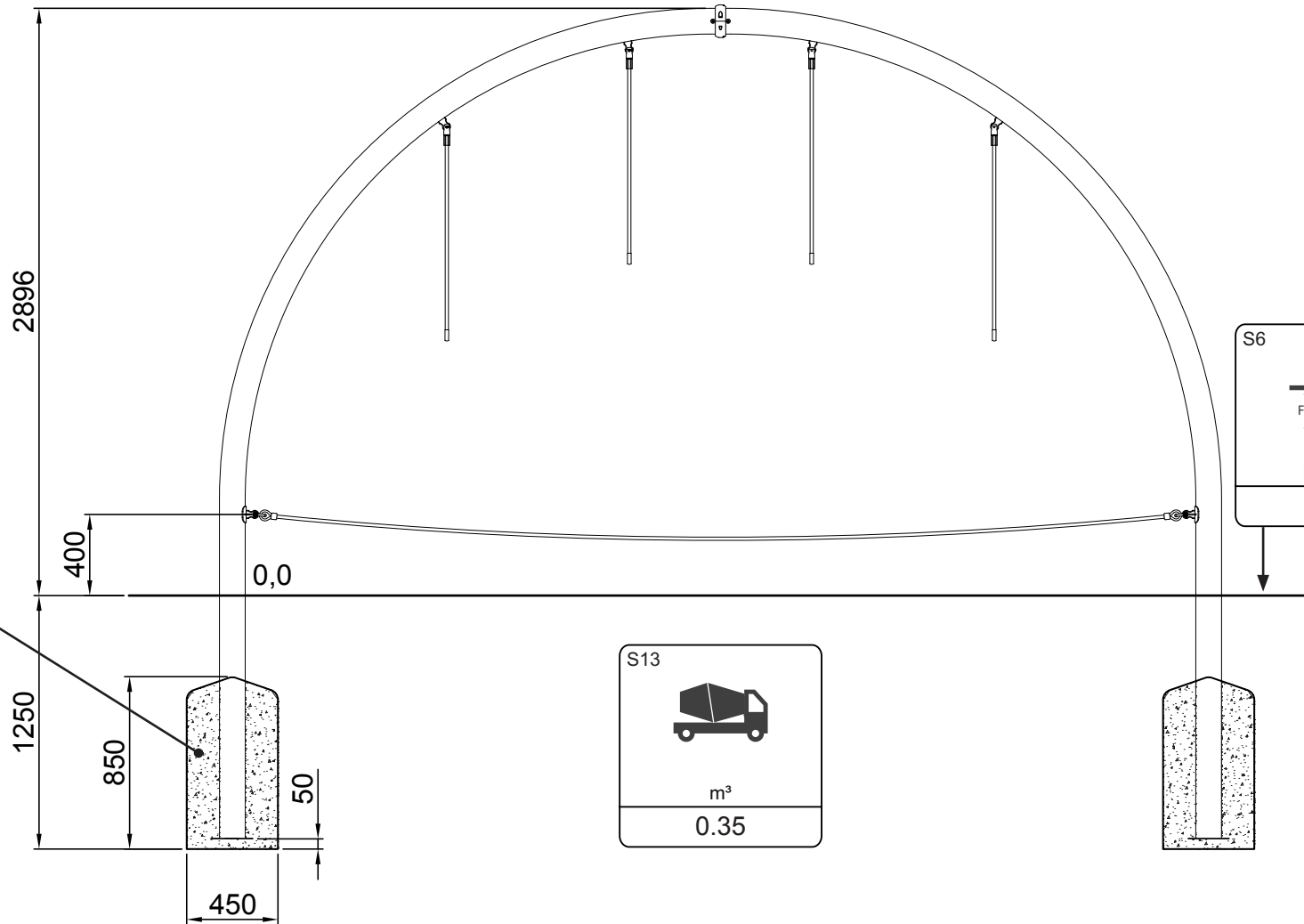
 101

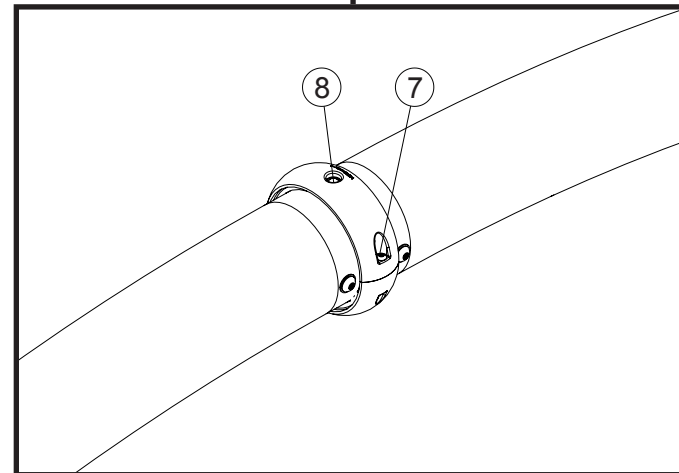
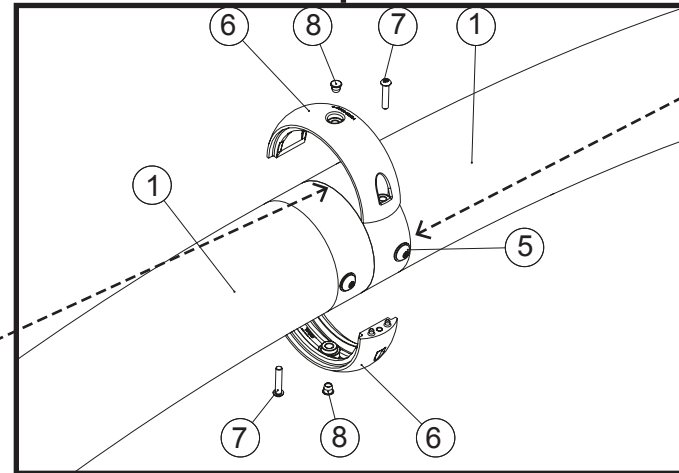
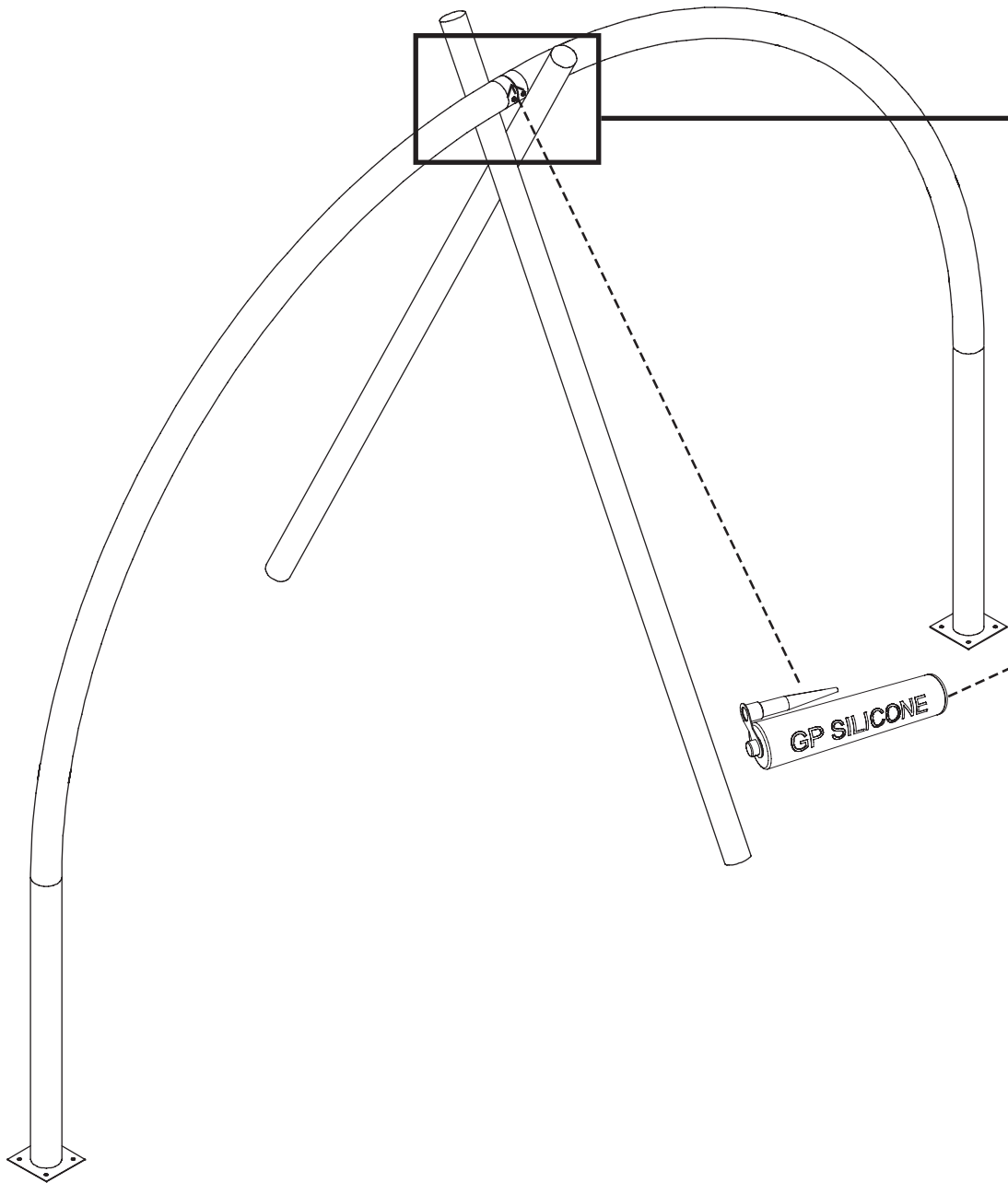

S11



Nm
20-25

