

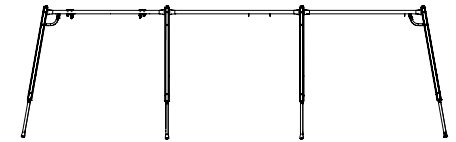











CC

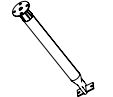

1	SW54318		1x L=3257	30.74kg
2	SW54322		1x L=3580	32.81kg
3	SW80894		1x L=3257	34.48kg
4	SW71678		3x	0.291kg
5	32-03249		2x 500x430x300 mm	2.86kg
6	32-01850		8x	4.90kg
7	8005537		16x Ø35x20 mm	0.01kg
8	8042811		6x ISO7042-M12-8	0.018kg
9	8008834		18x Ø12,5x30x3 mm	0.01kg
10	SW57020		2x	0.76kg
11	SW73082		8x Ø108.5 x 2495 mm	7.40kg
12	8008425		4x ISO4014-M12x130-8.8	0.1317kg

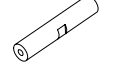
13	8008421		8x ISO4014-M12x90-8.8	0.0961kg
----	---------	--	-----------------------	----------

14	8008411		2x ISO4017-M12x30-8.8	0.0429kg
----	---------	---	-----------------------	----------

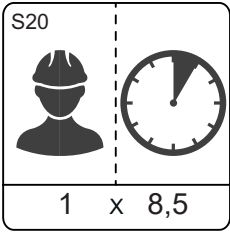
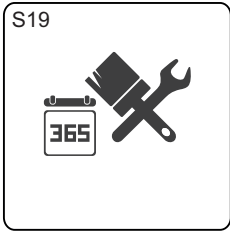
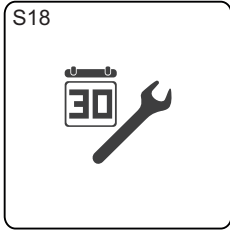
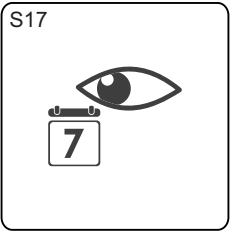

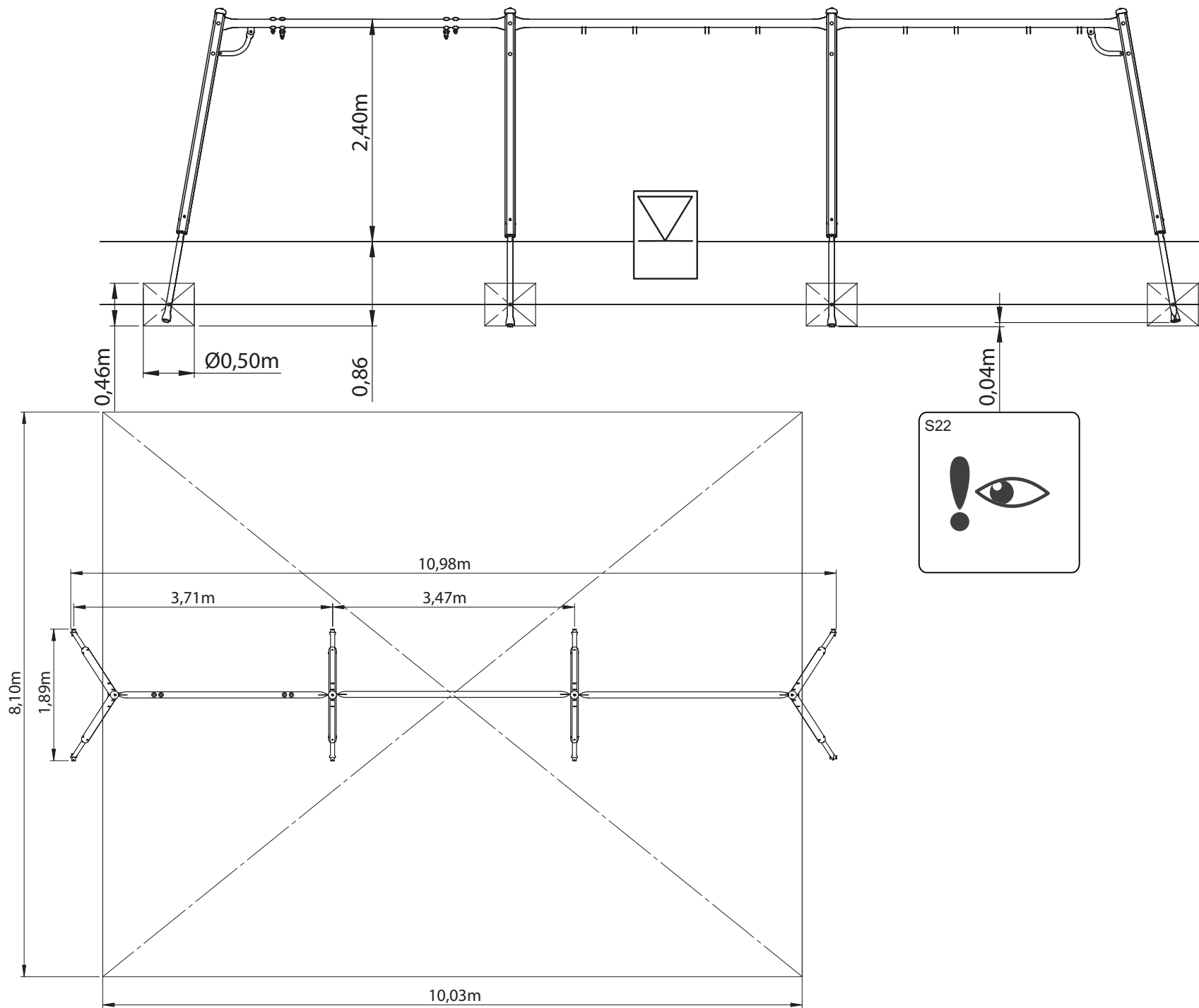



1220

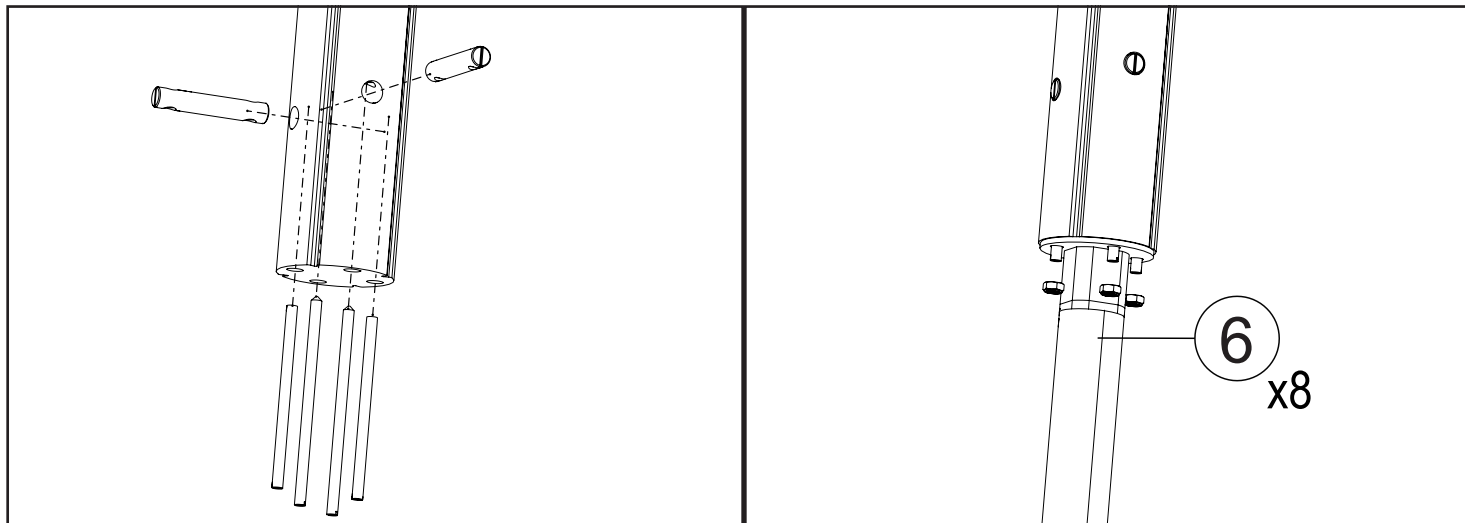
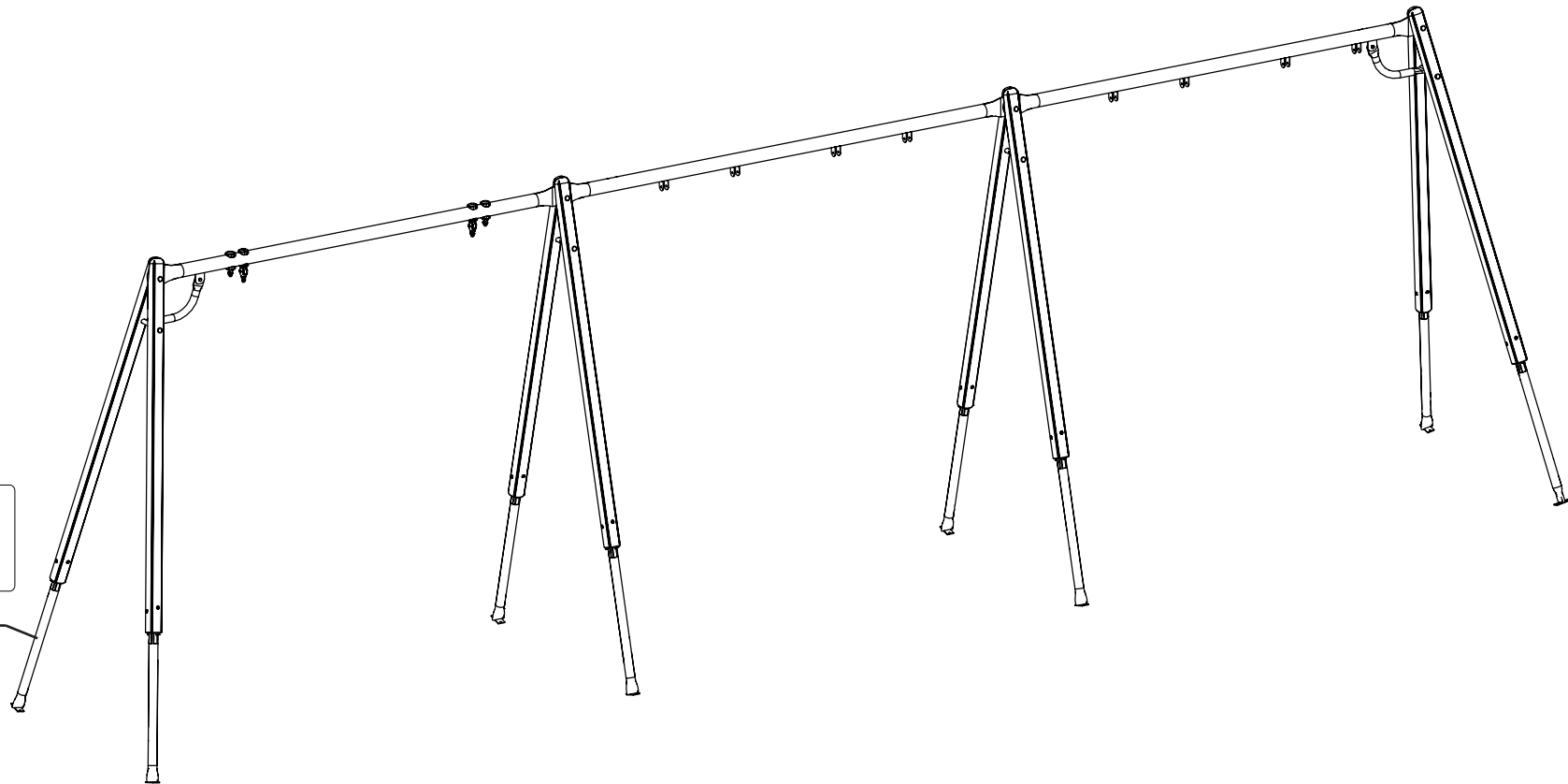

S11



Nm
81nM

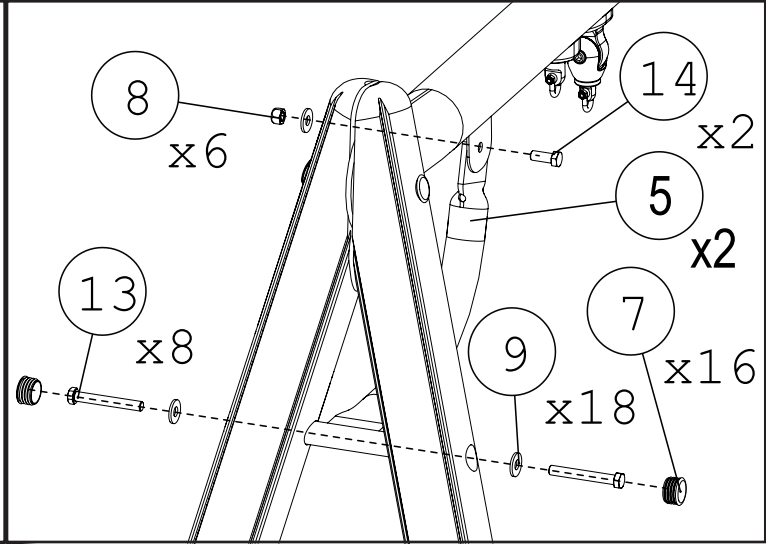
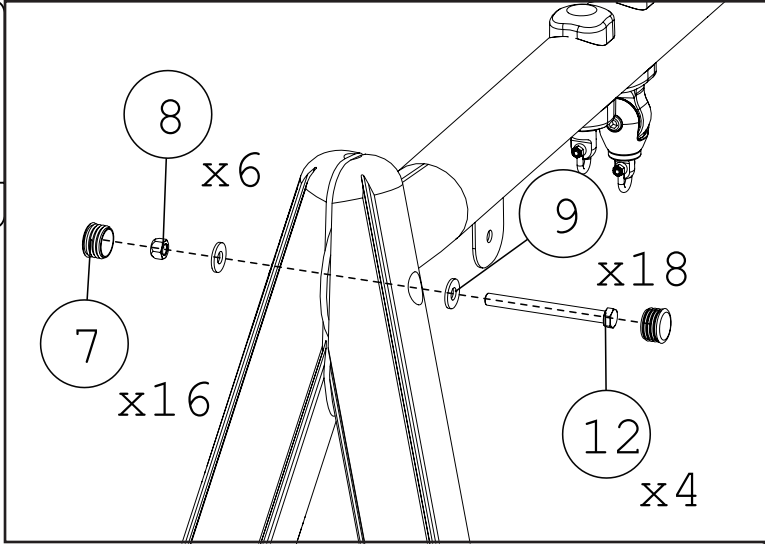

S11



Nm
81nM

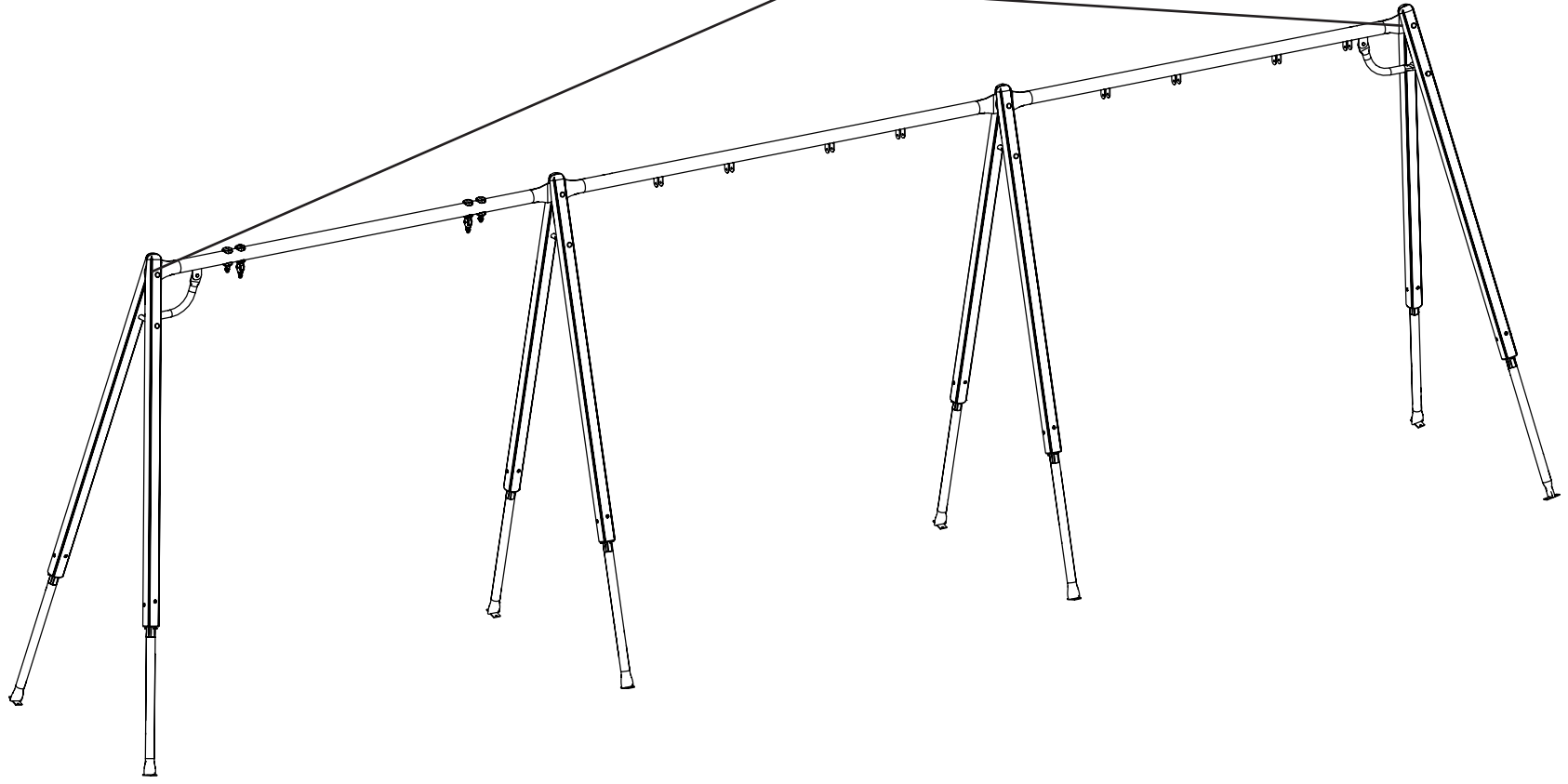

S11



Nm
81nM

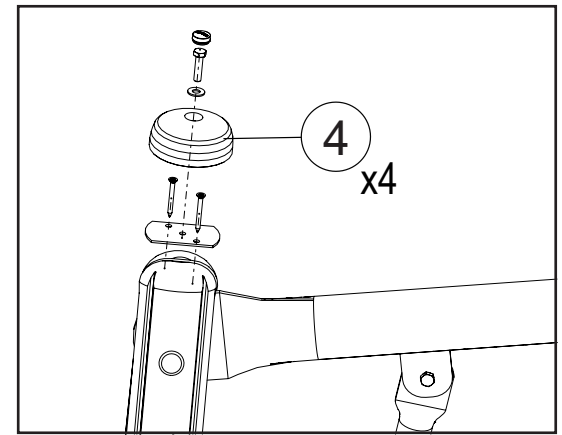
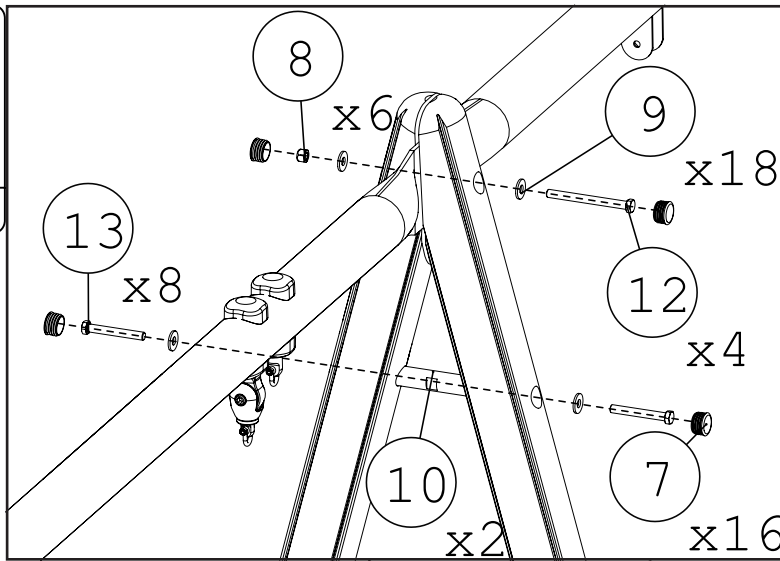

S22



1227

