

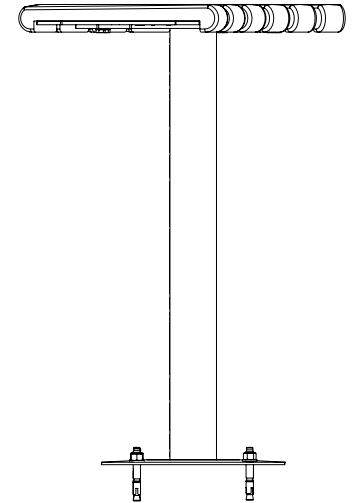





OM



1	SW92053		1x 563 x 379 x 45	4.76kg
2	SW76516		1x Ø300 x 720	6.72kg
3	8008559		4x M12x86 HDG	0.06kg
4	8008340		8x ISO4017-M8x16-8.8	0.013kg
5	8050049		8x ISO7089-8.4x16x1.6	0.002kg

S17



S18



S19



S20



1 x 0,5

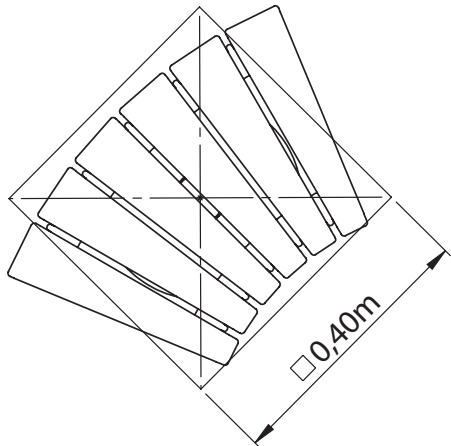
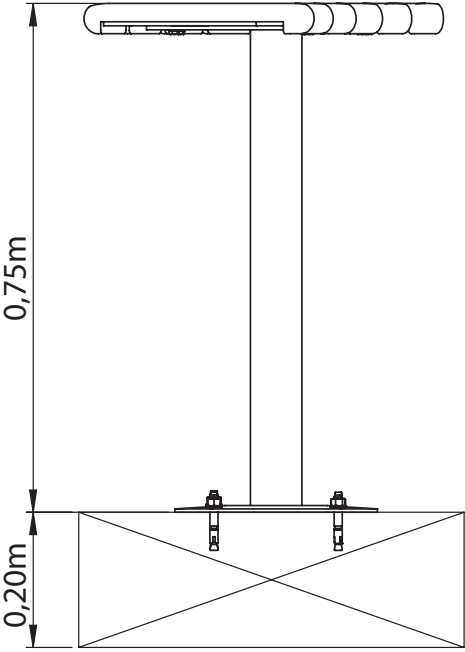
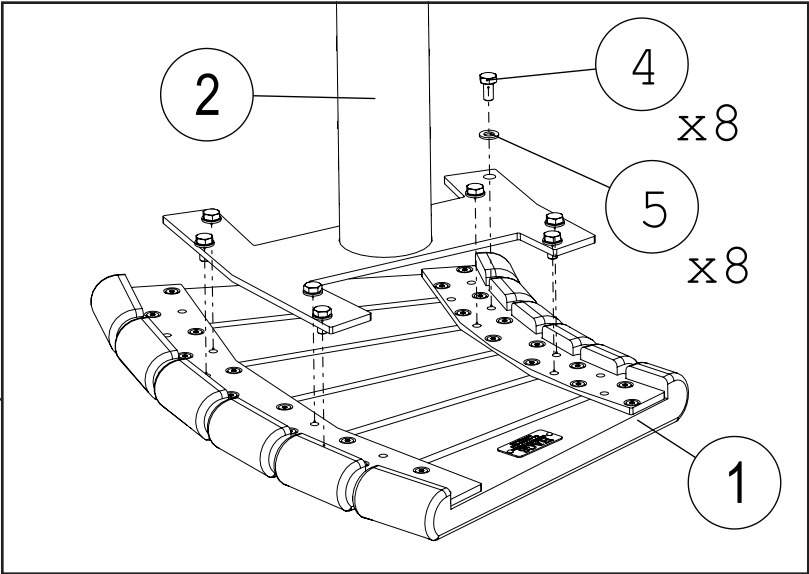
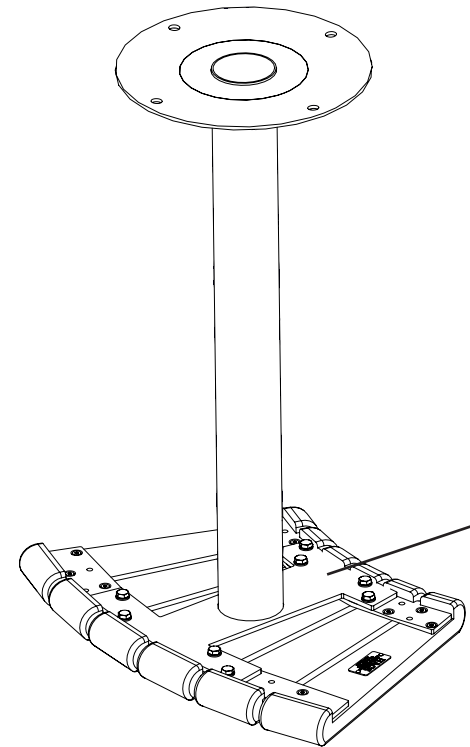

S25



≥C20/25
S1-S3



1x24h



101

