

7.65m
4.20m

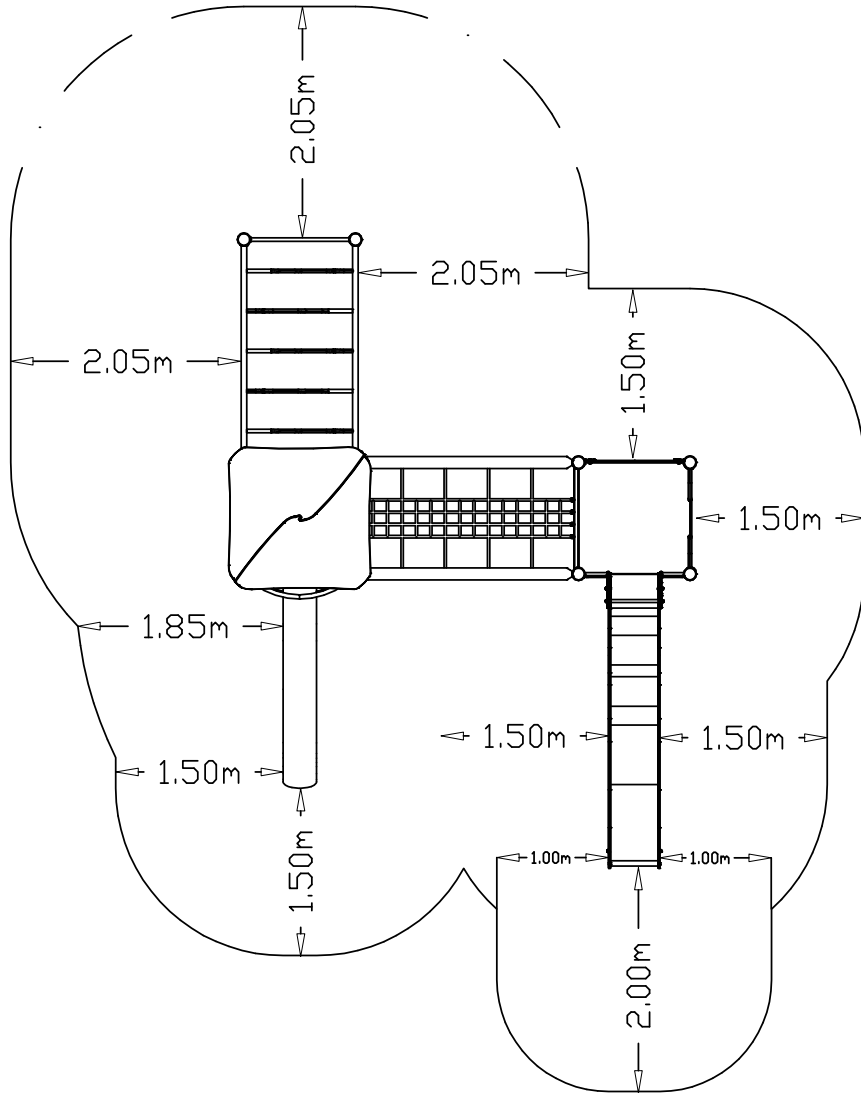

5.70m
9.75m

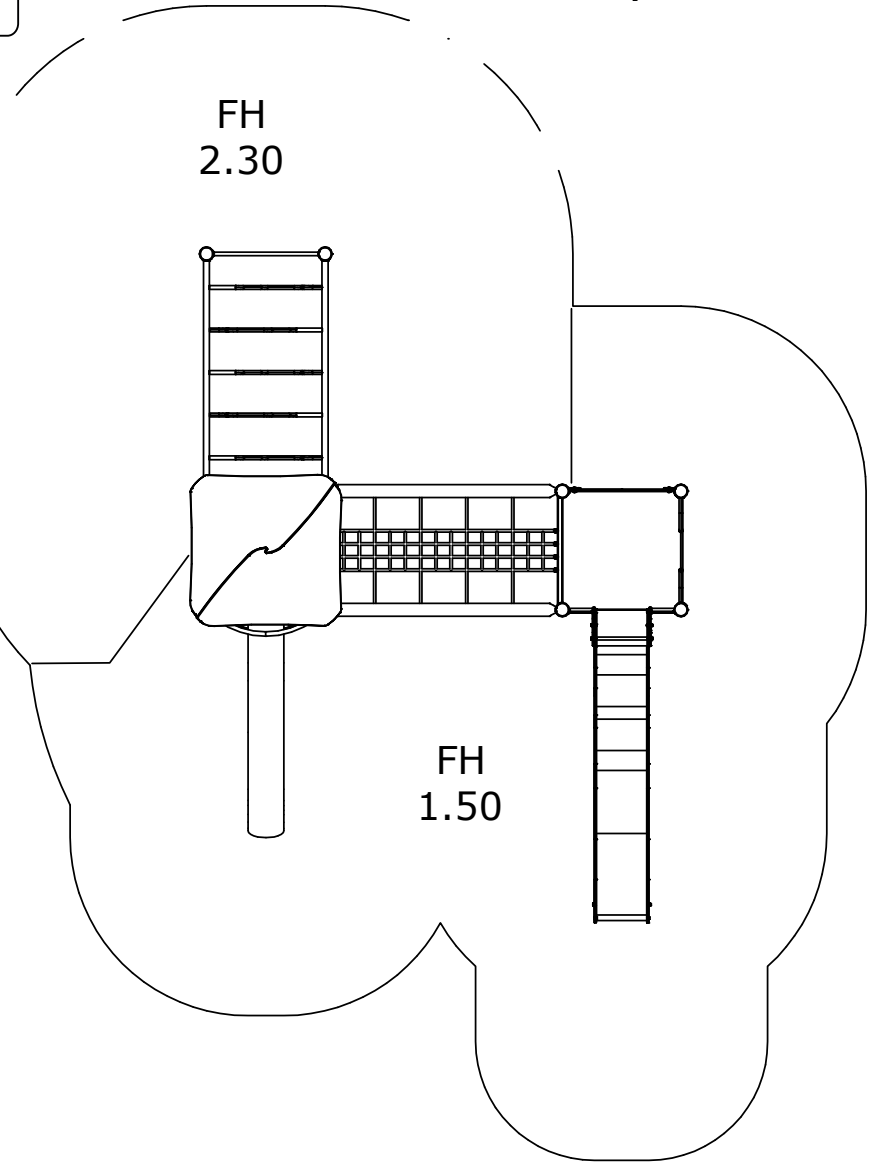

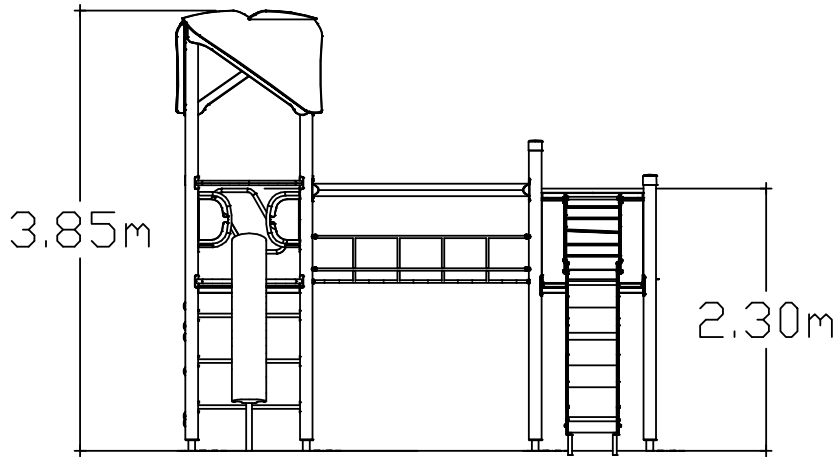
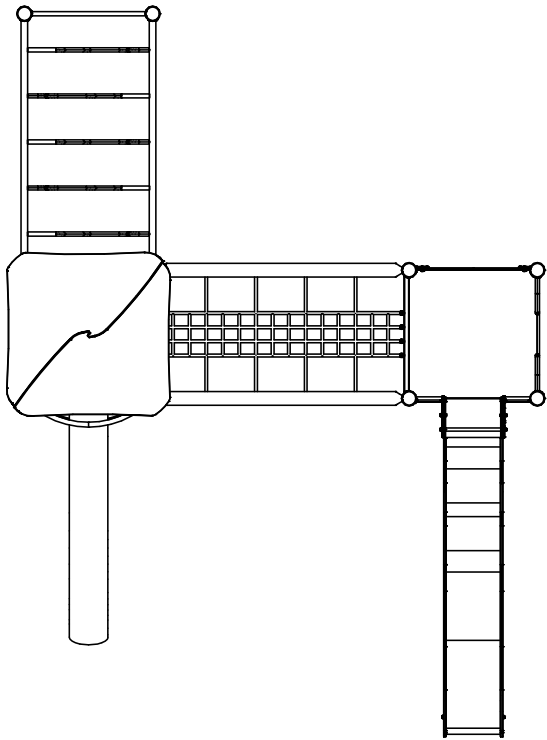

42008010

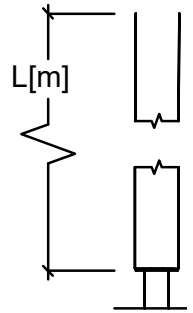
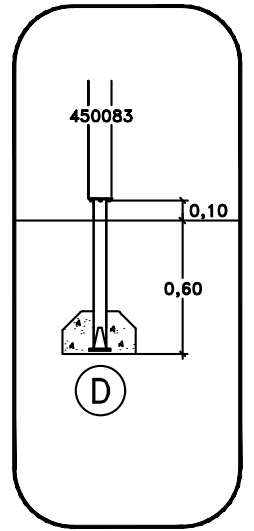
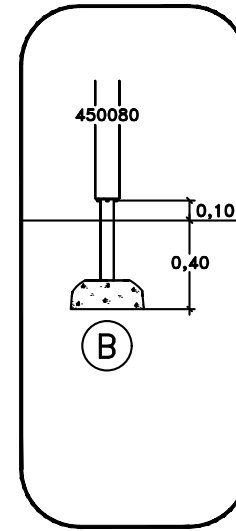
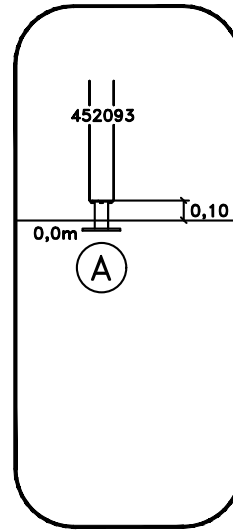
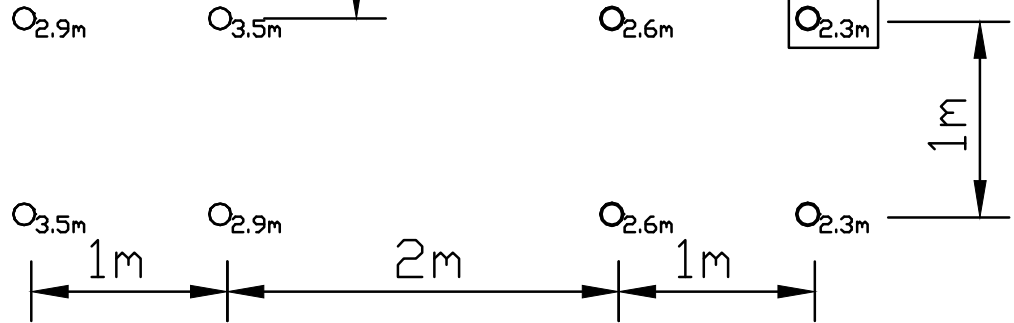
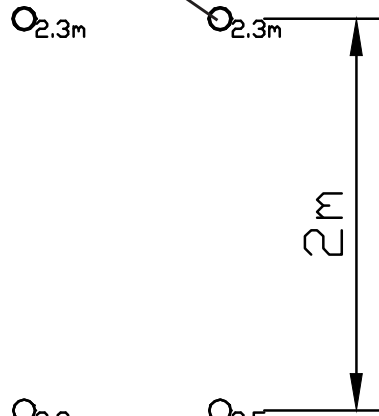

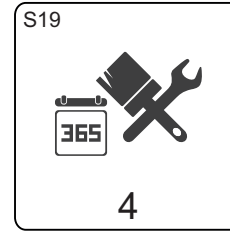
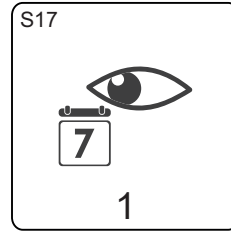
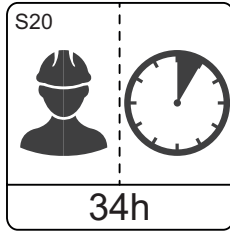

260329
441000
42008010
MA45060520
MA45074115
MA450994
MA452213 [OM]
MA453213 [SF]
MA454213 [BM]
MA62693
MASW39102
MASW39775
MASW42193
MASW63820
MASW78720
ST4203

42008010

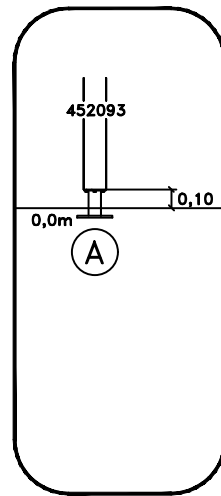

OM
Above Ground

8105986
80 _____
80 _____
80 _____

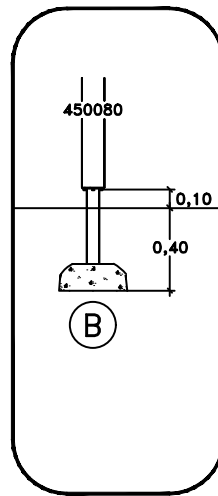

SF
Sunken Foundation

8105990
80 _____
80 _____
80 _____

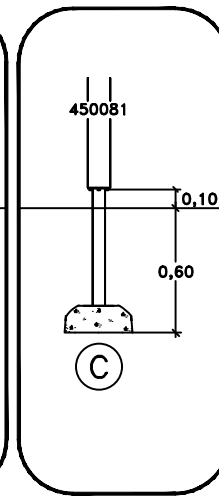

CC
Cast In Place

8077989
8105983
80 _____
80 _____

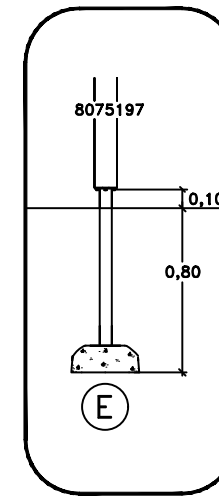
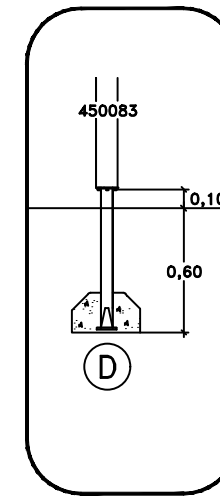

BM
Loosefill

80 _____
80 _____
80 _____
80 _____

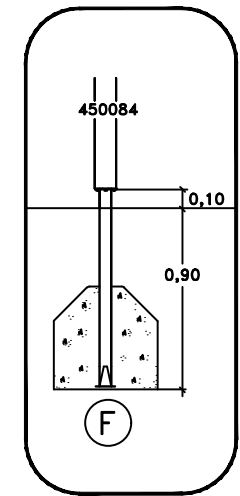

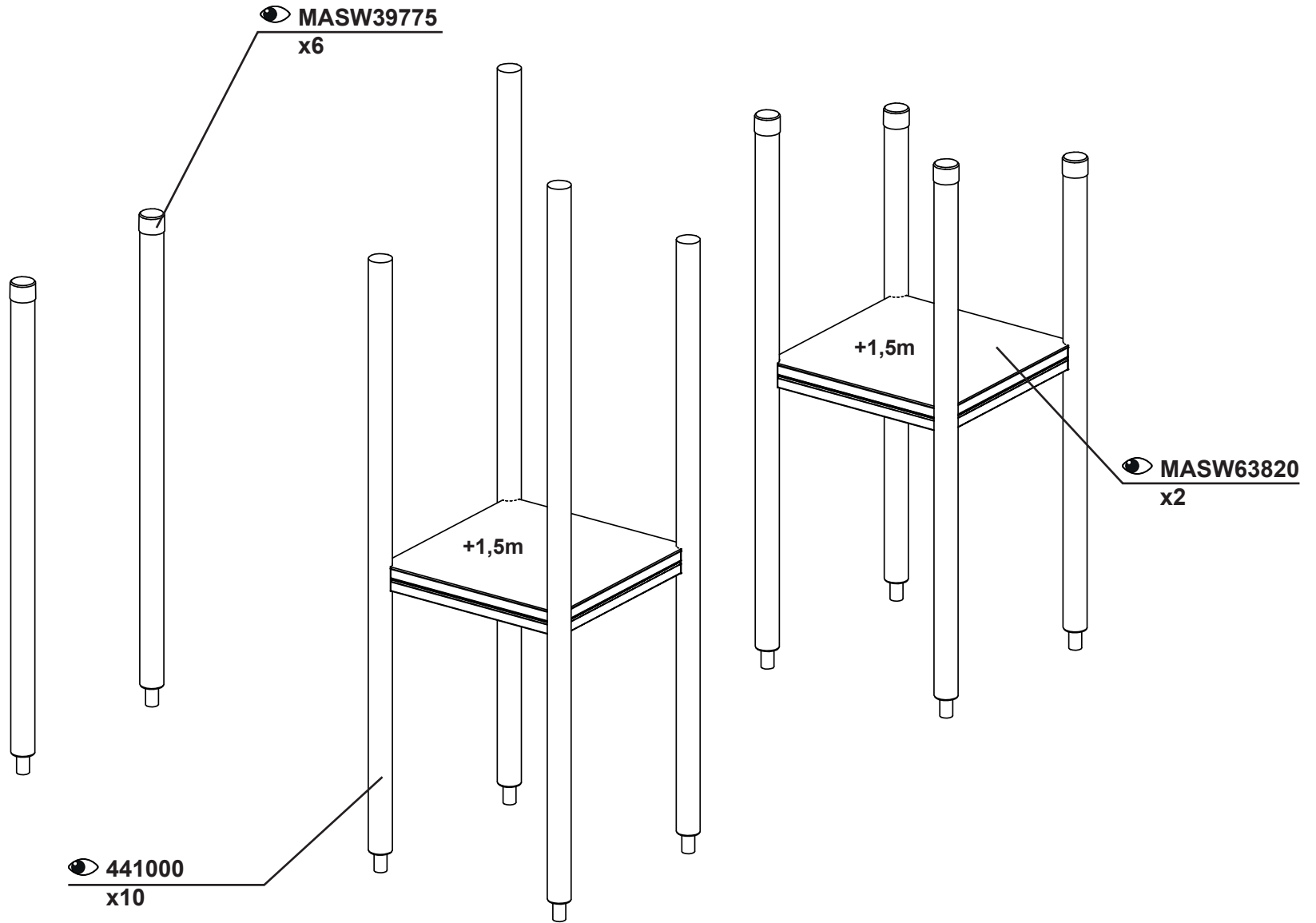
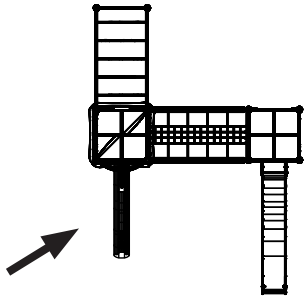

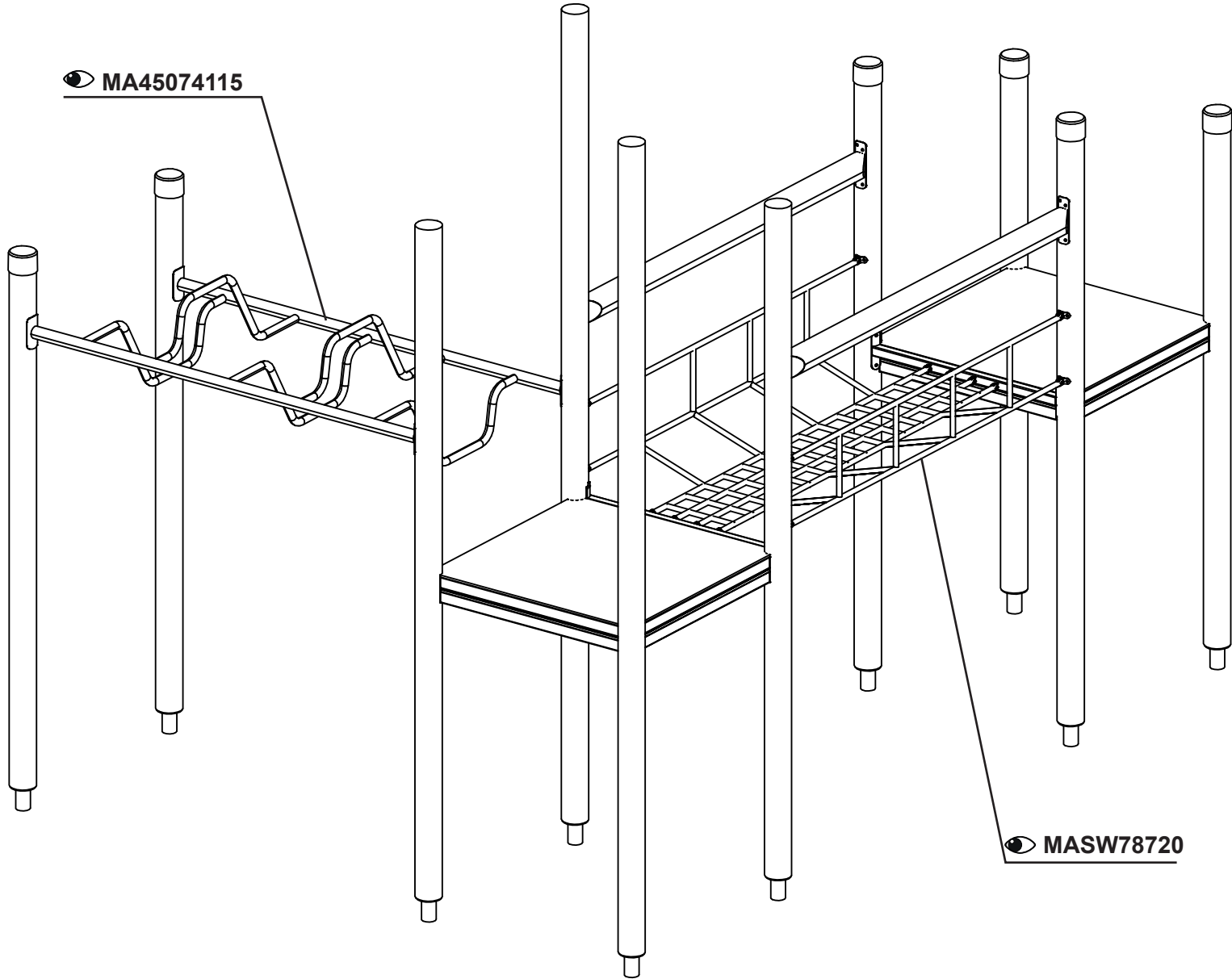
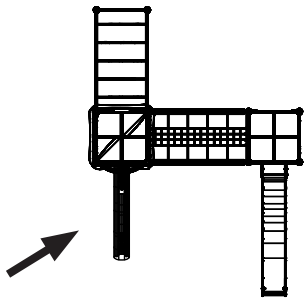

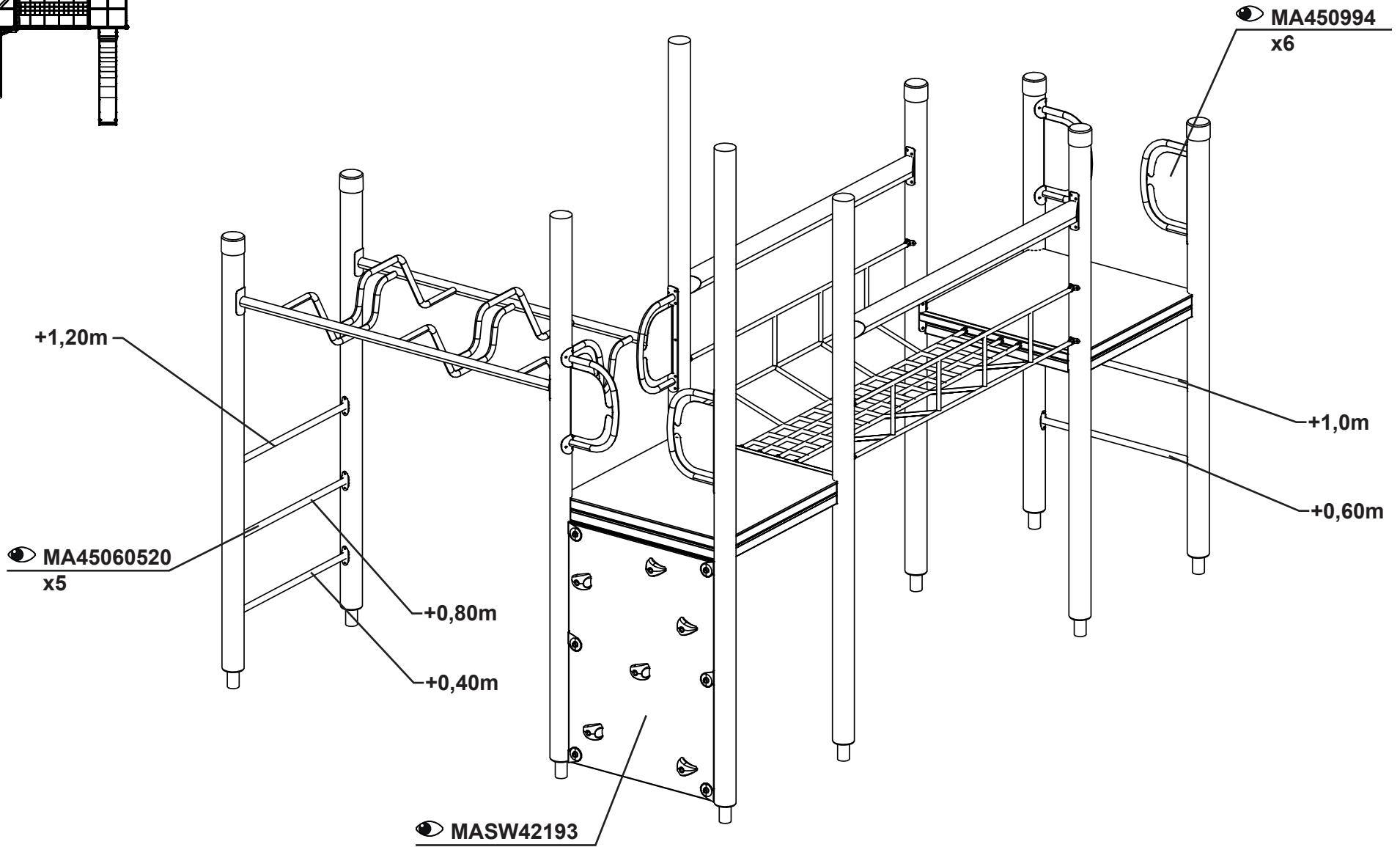
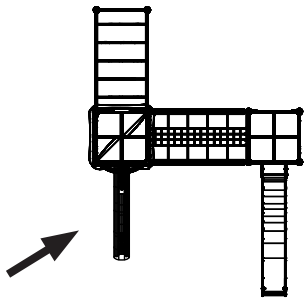

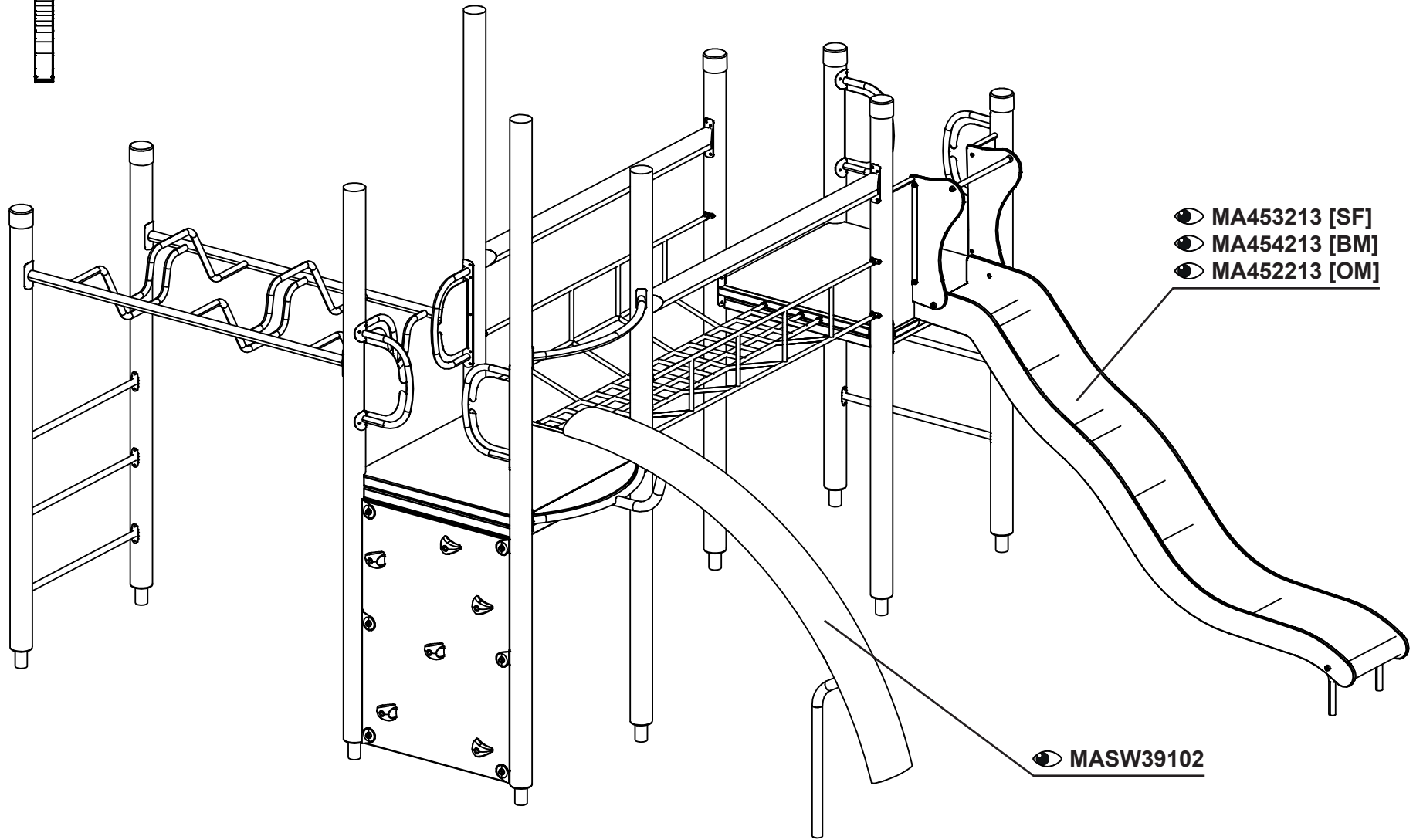
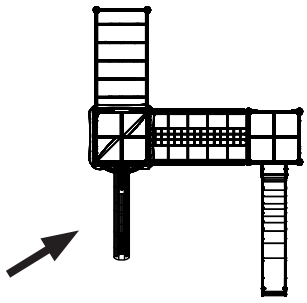

- MA453213 [SF]
- MA454213 [BM]
- MA452213 [OM]

● MASW39102

