

EN 1176



S6



EN1176

1.60m

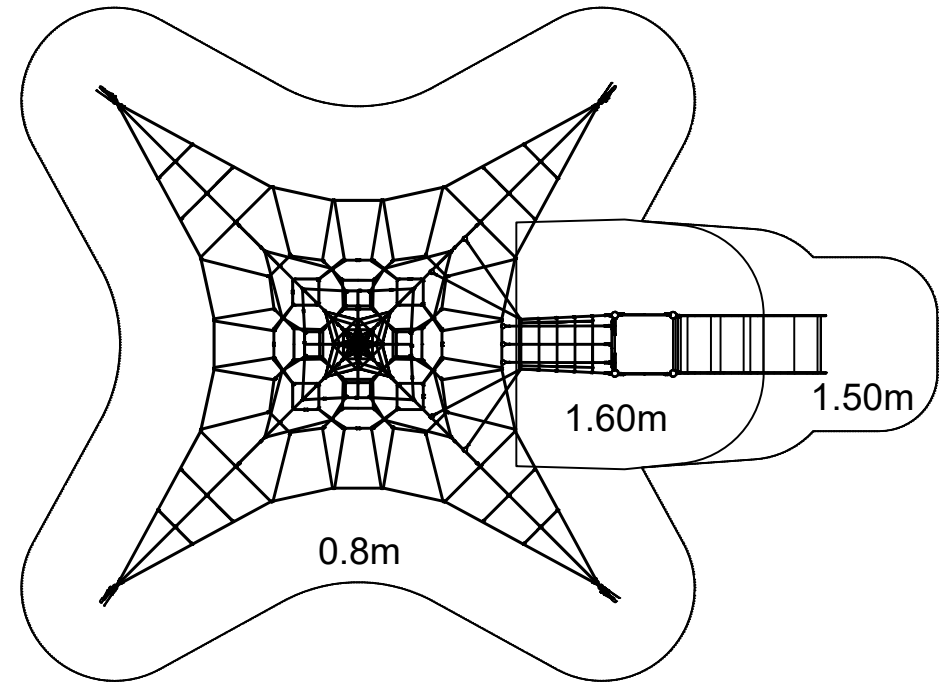
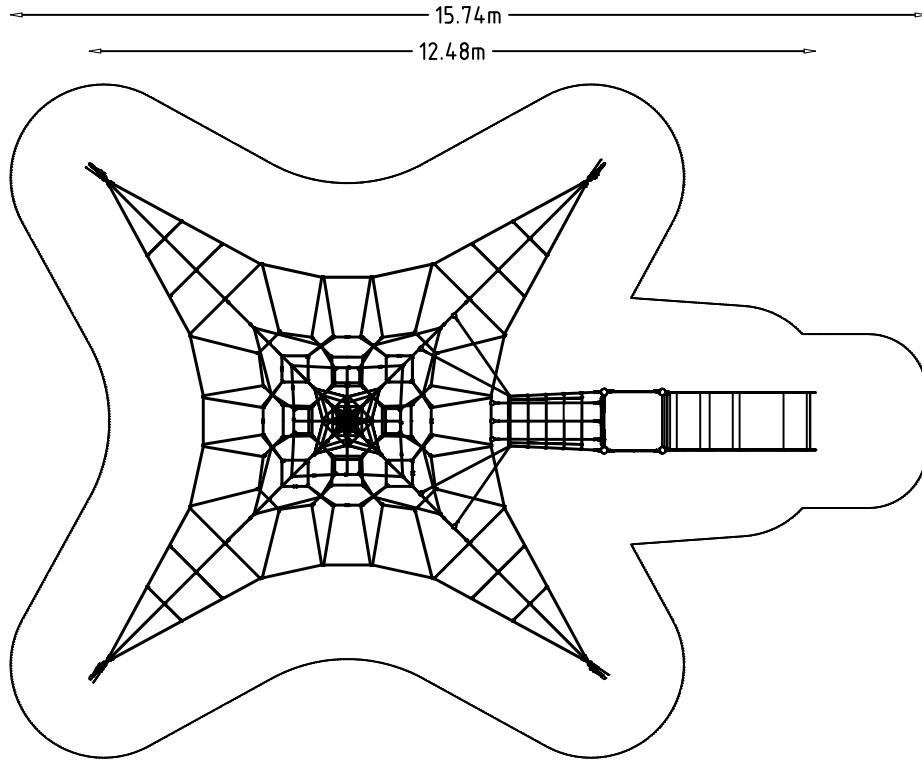

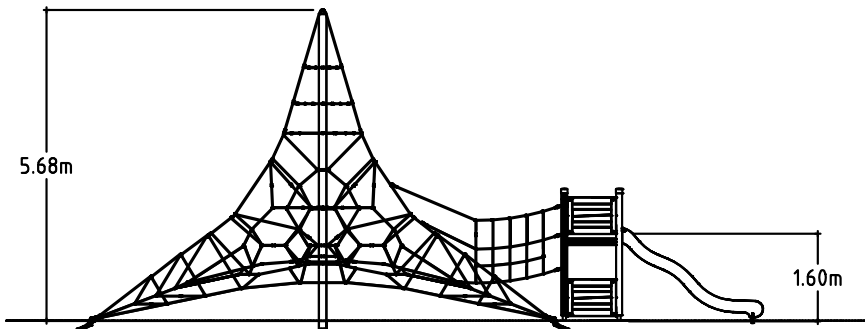
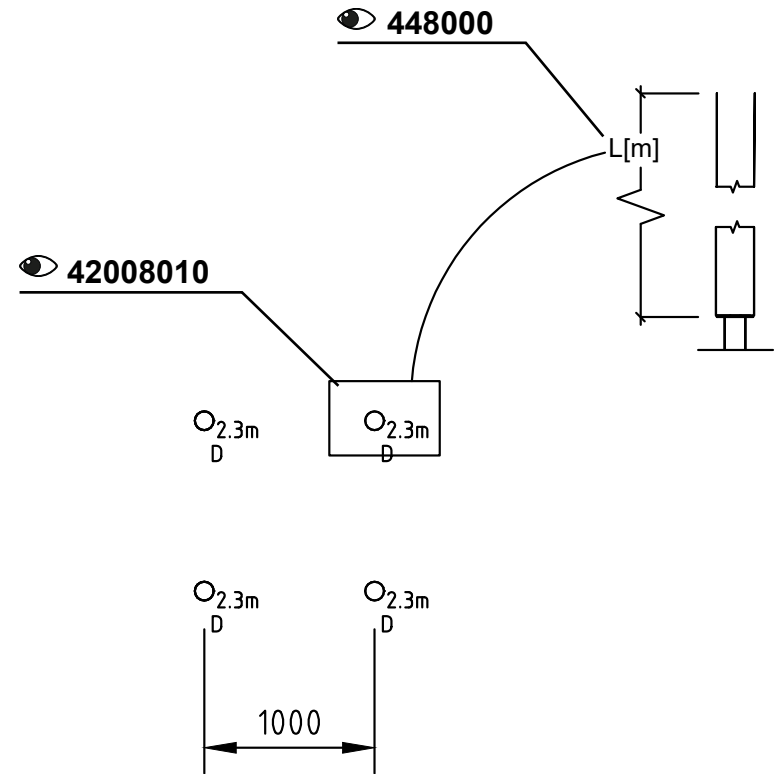
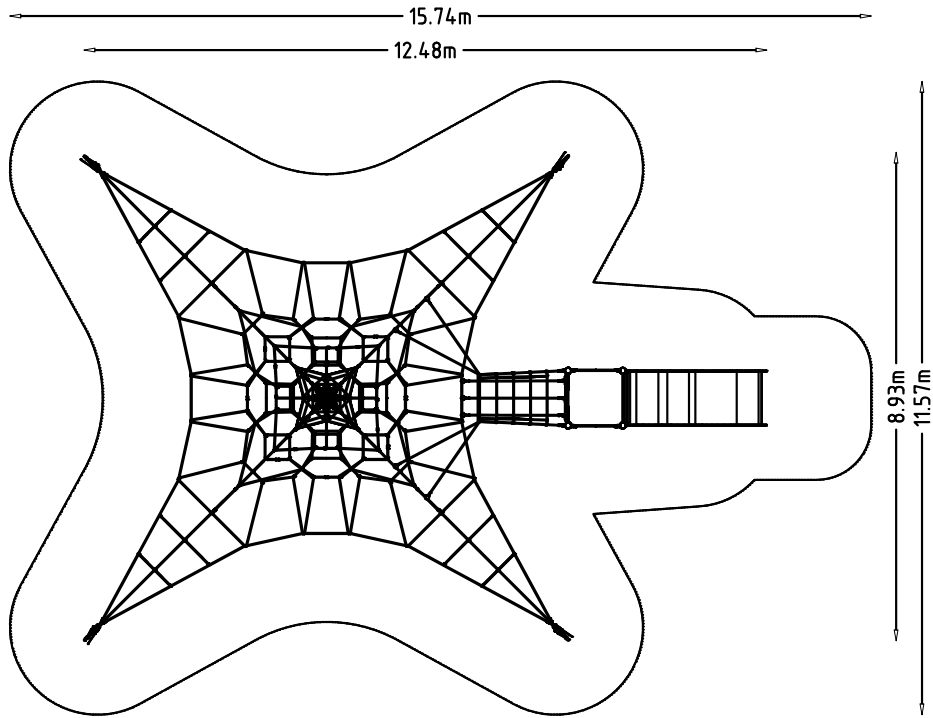

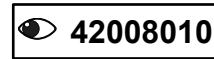
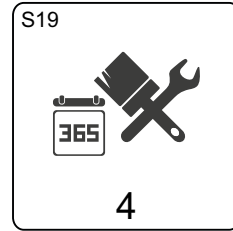
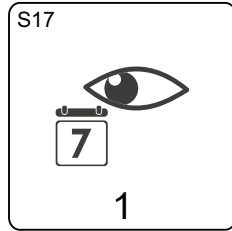
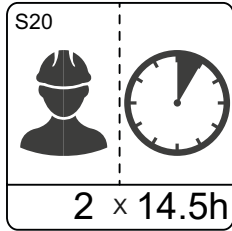
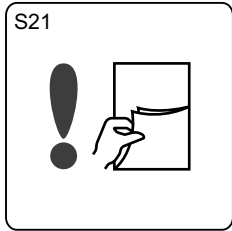

448000
42008010
Active6000
MASW39775
MASW36415
MASW67941[Sf]
MASW67923[OM]
MASW67943[BM]
260329

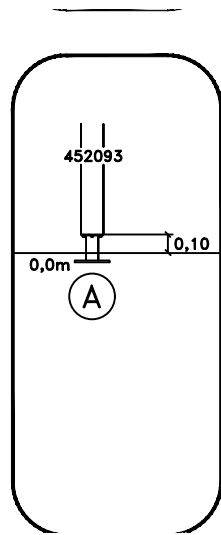

OM

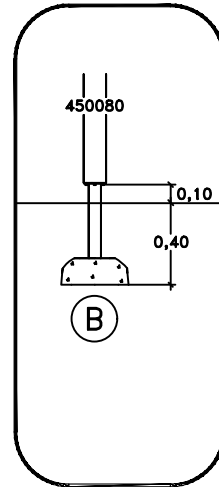

SF

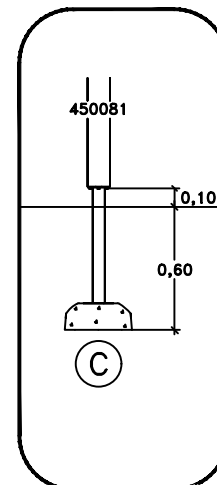

SF

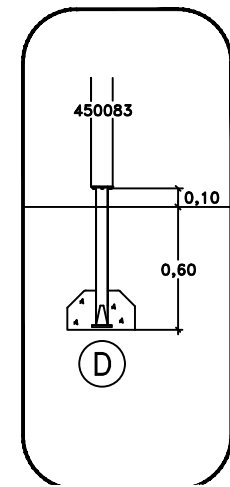

CC

Above Ground Sunken Foundation Sunken Foundation Cast In Place

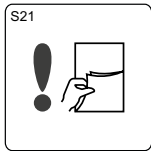
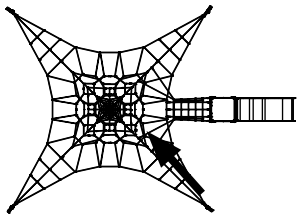

● **Active 6000**

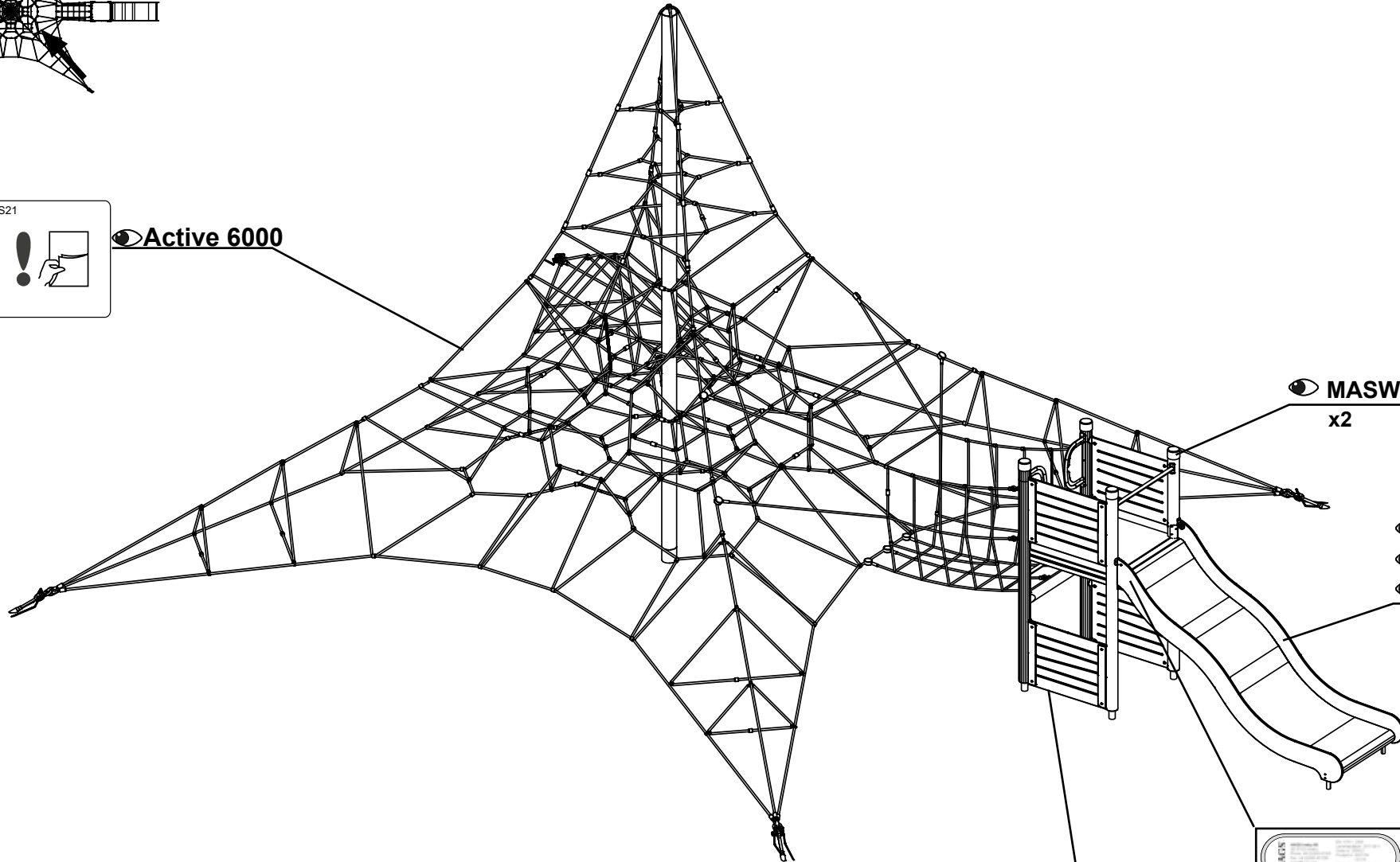

● **MASW39775**
x2

- **MASW67941 [SF]**
- **MASW67923 [OM]**
- **MASW67943 [BM]**

 **260329**

● **MASW106791**