

EN 1176



S6



EN1176

1.60m

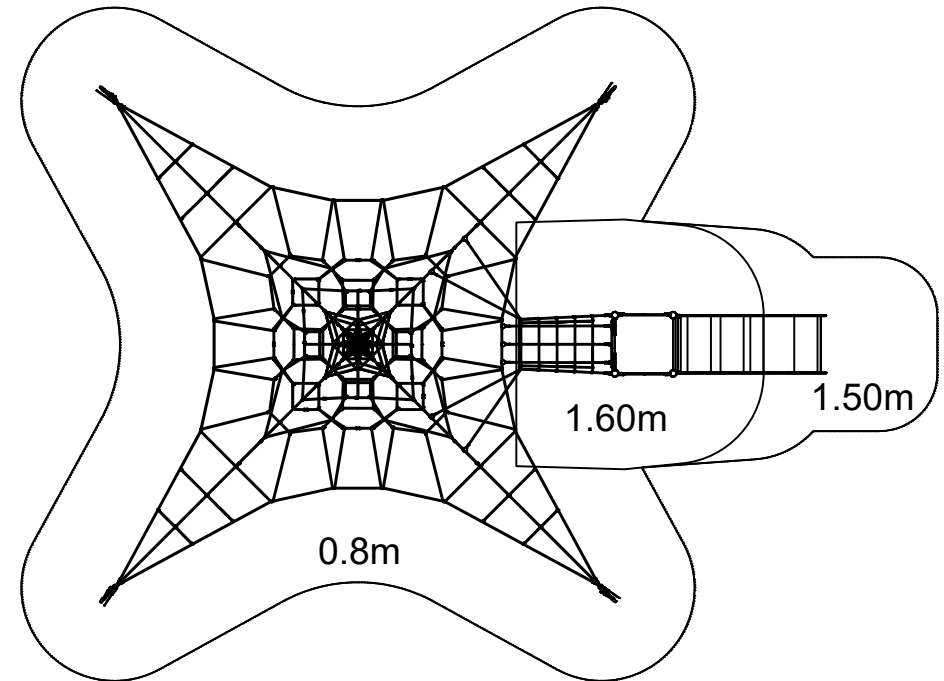
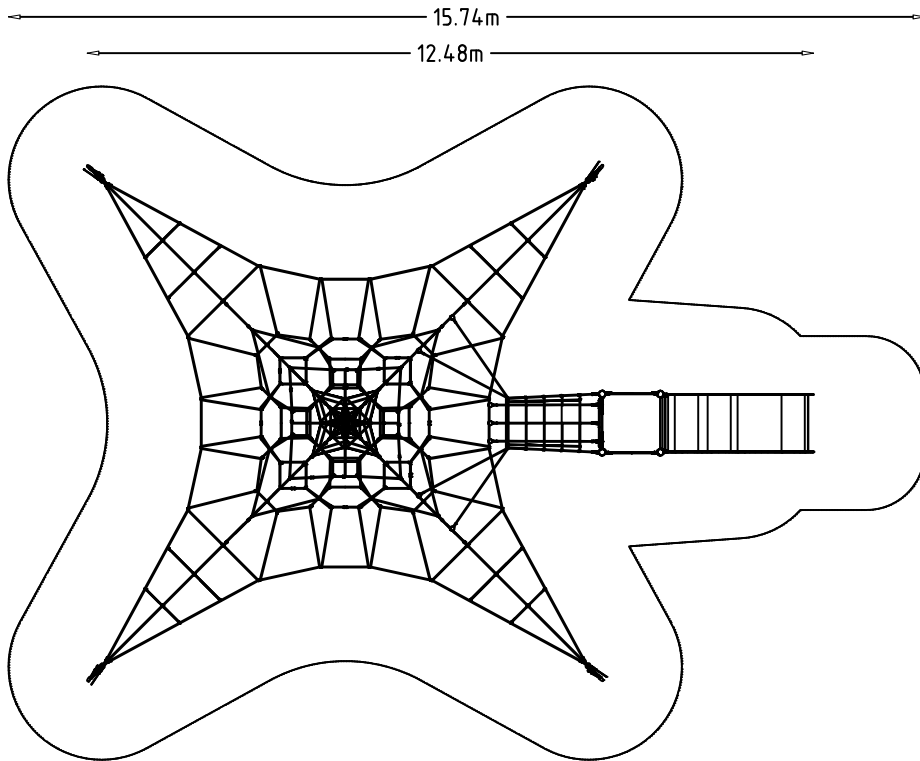

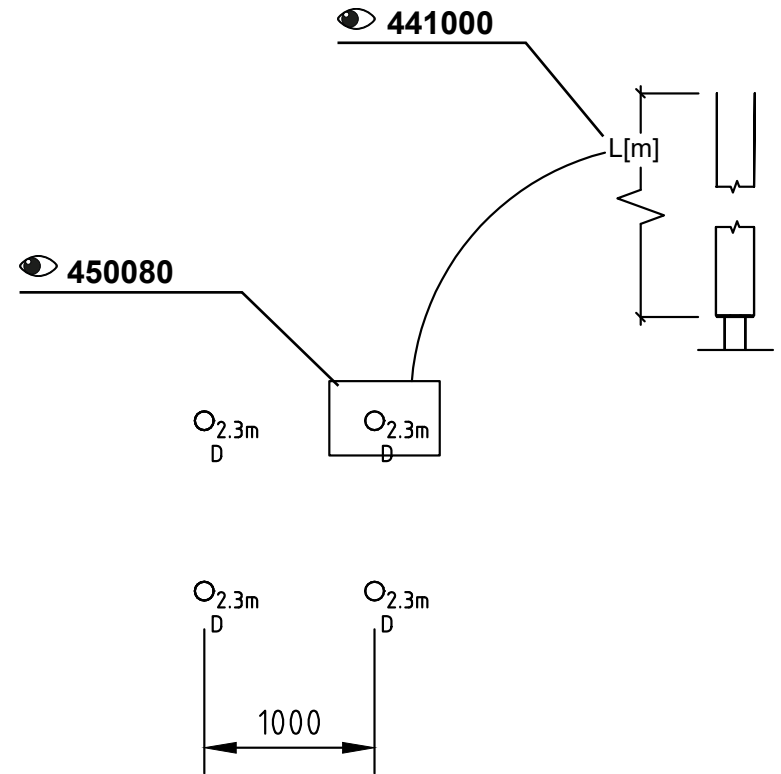
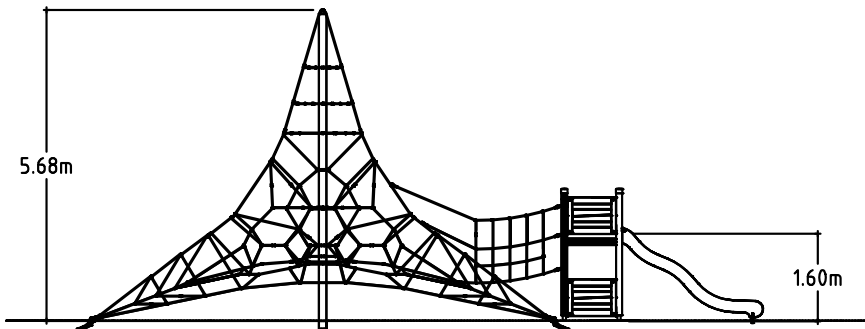
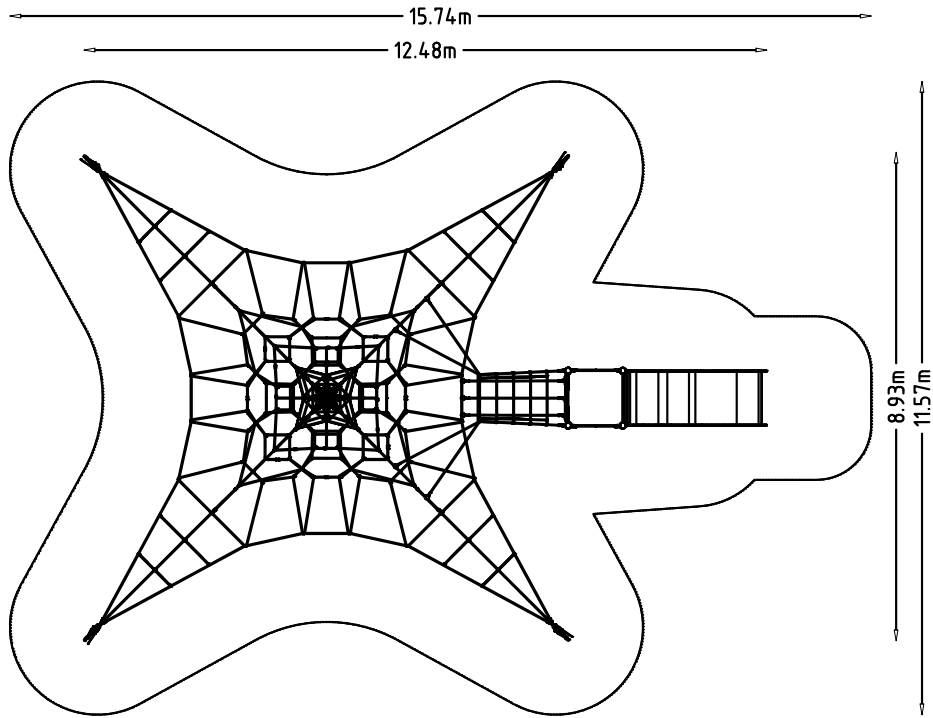

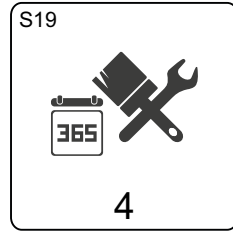
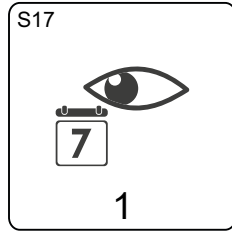
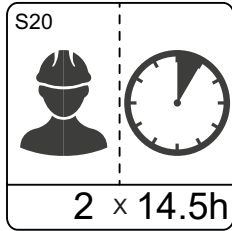
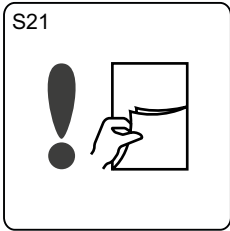

**450080**  
**441000**  
**Active6000**  
**MASW39775**  
**MASW36415**  
**MASW67953[Sf]**  
**MASW67949[OM]**  
**MASW67954[BM]**  
**260329**

42008010

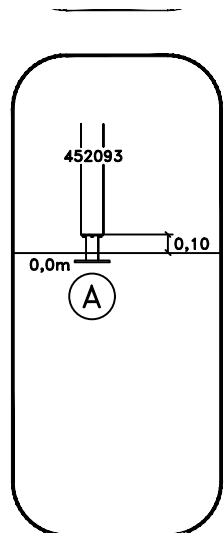

**OM**

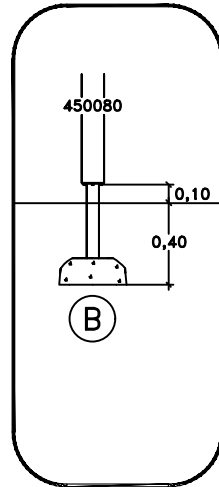

**SF**

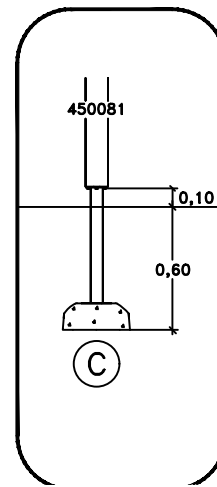

**SF**

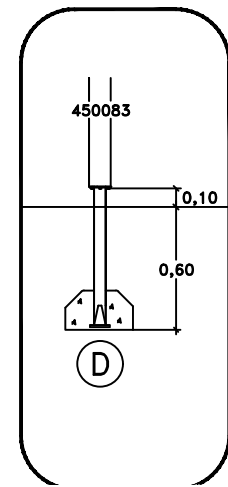

**CC**

**Above Ground Sunken Foundation Sunken Foundation Cast In Place**

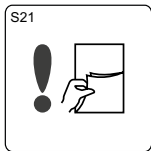
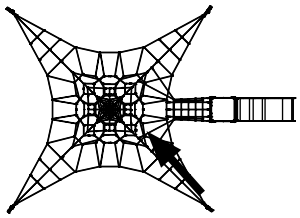

Active 6000

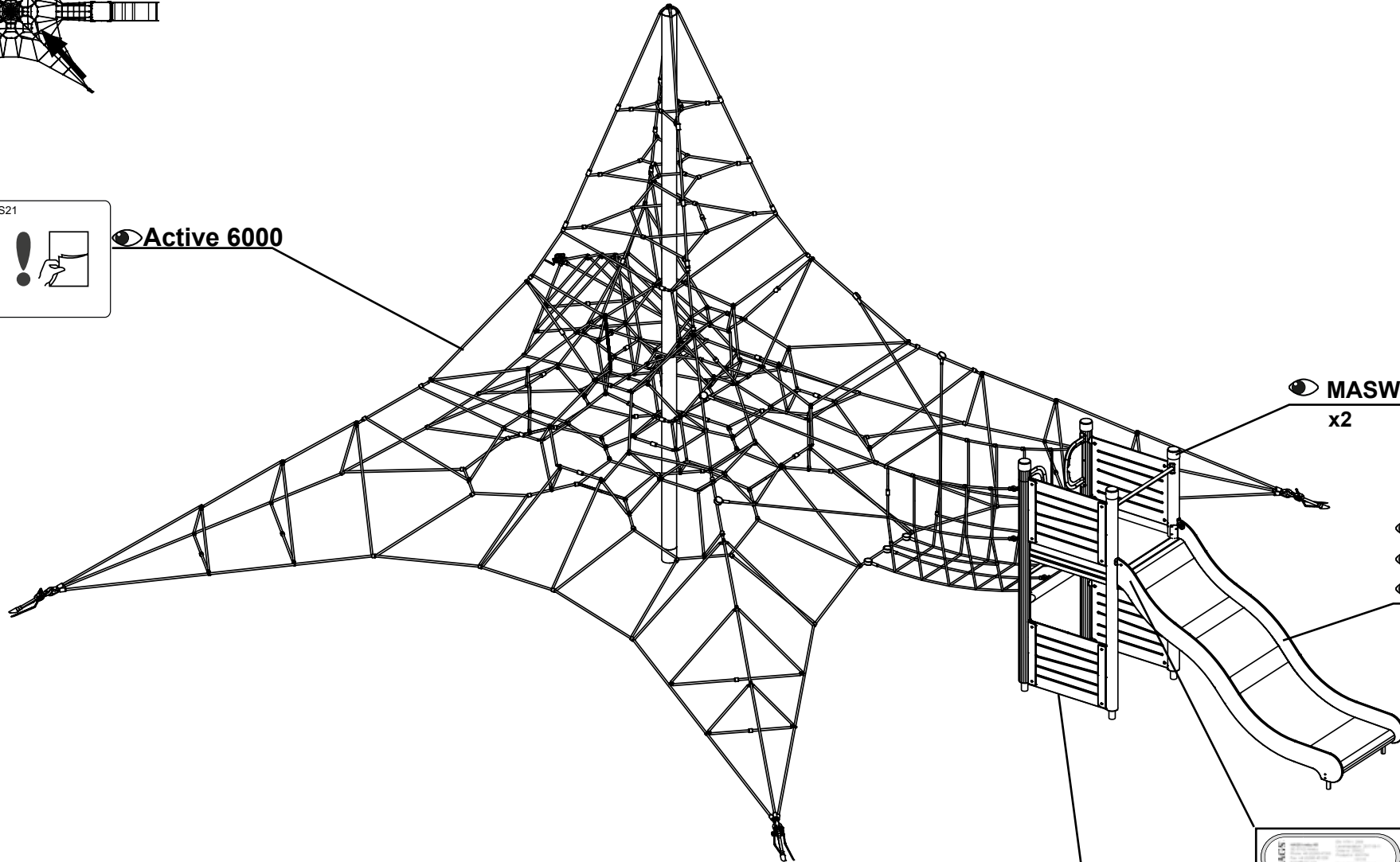

MASW39775  
x2

- MASW67953 [SF]
- MASW67949 [OM]
- MASW67954 [BM]

HAGS  
260329

MASW104550