

EN 1176



S6



EN1176

1.60m

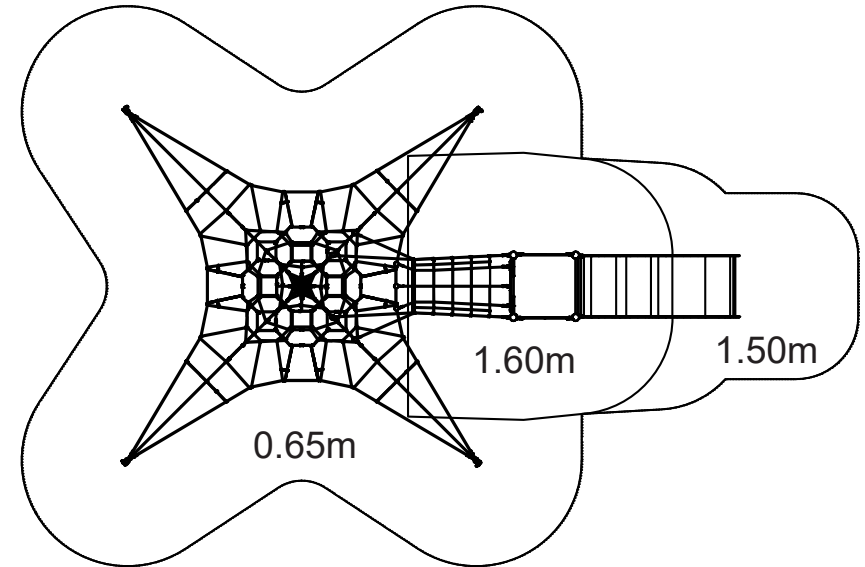
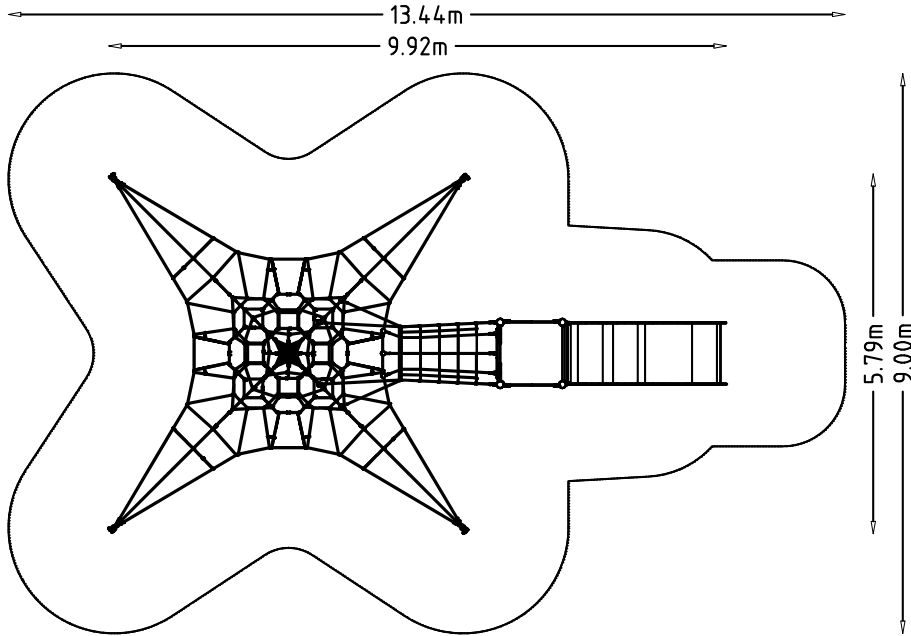

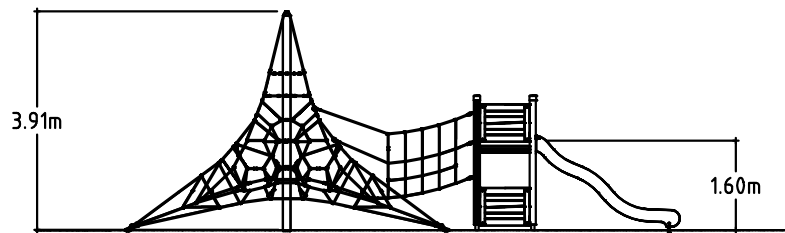
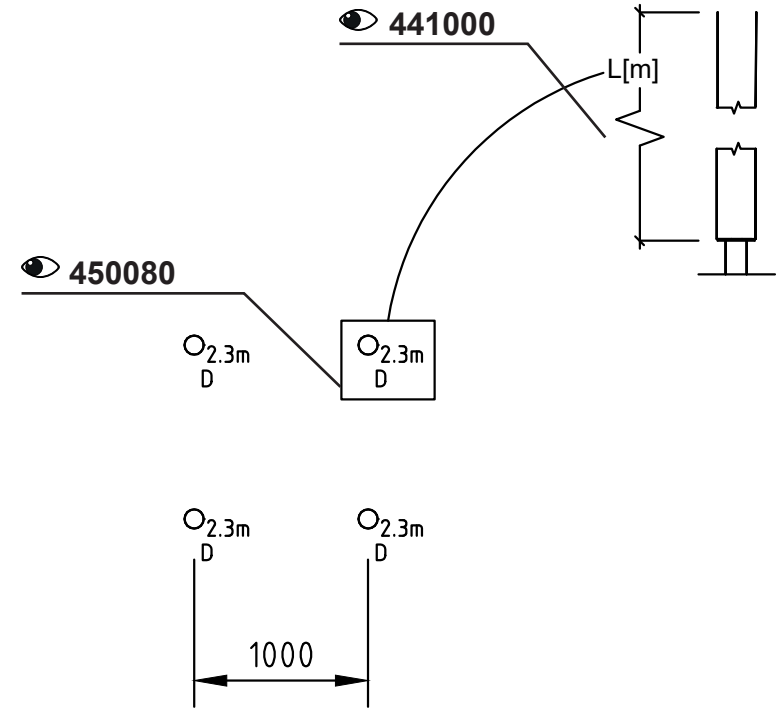
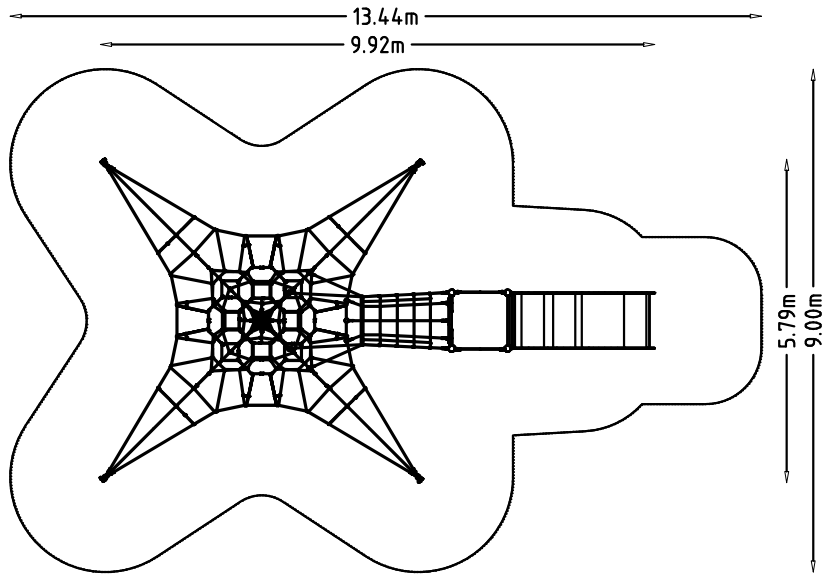

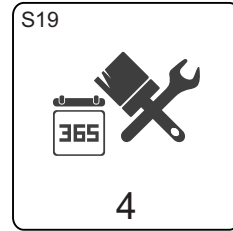
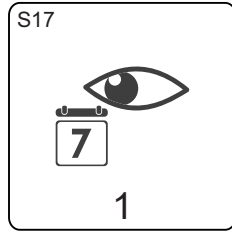
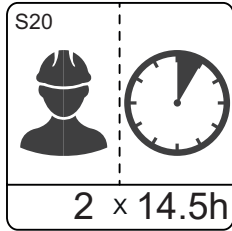
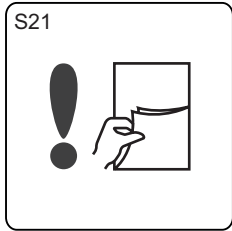

450080
441000
Active4000
MASW39775
MASW36415
MASW67953[SF]
MASW67949[OM]
MASW67954[BM]
260329

450080

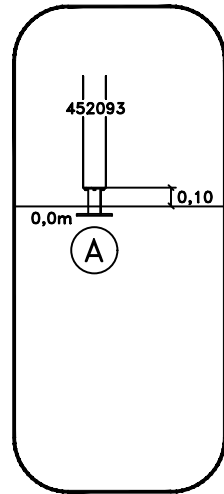

OM

Above Ground

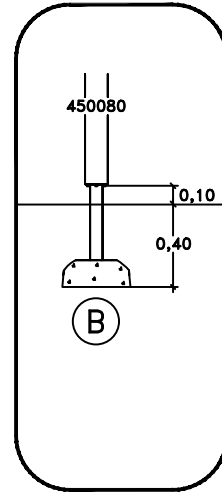

SF

Sunken Foundation

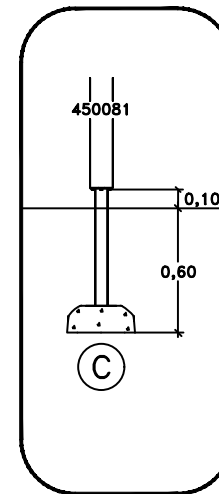

SF

Sunken Foundation

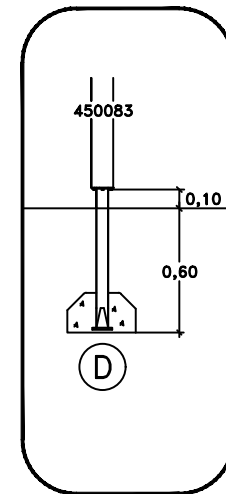

CC

Cast In Place

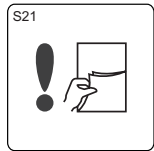
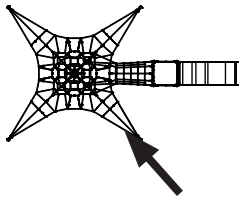

● Active 4000

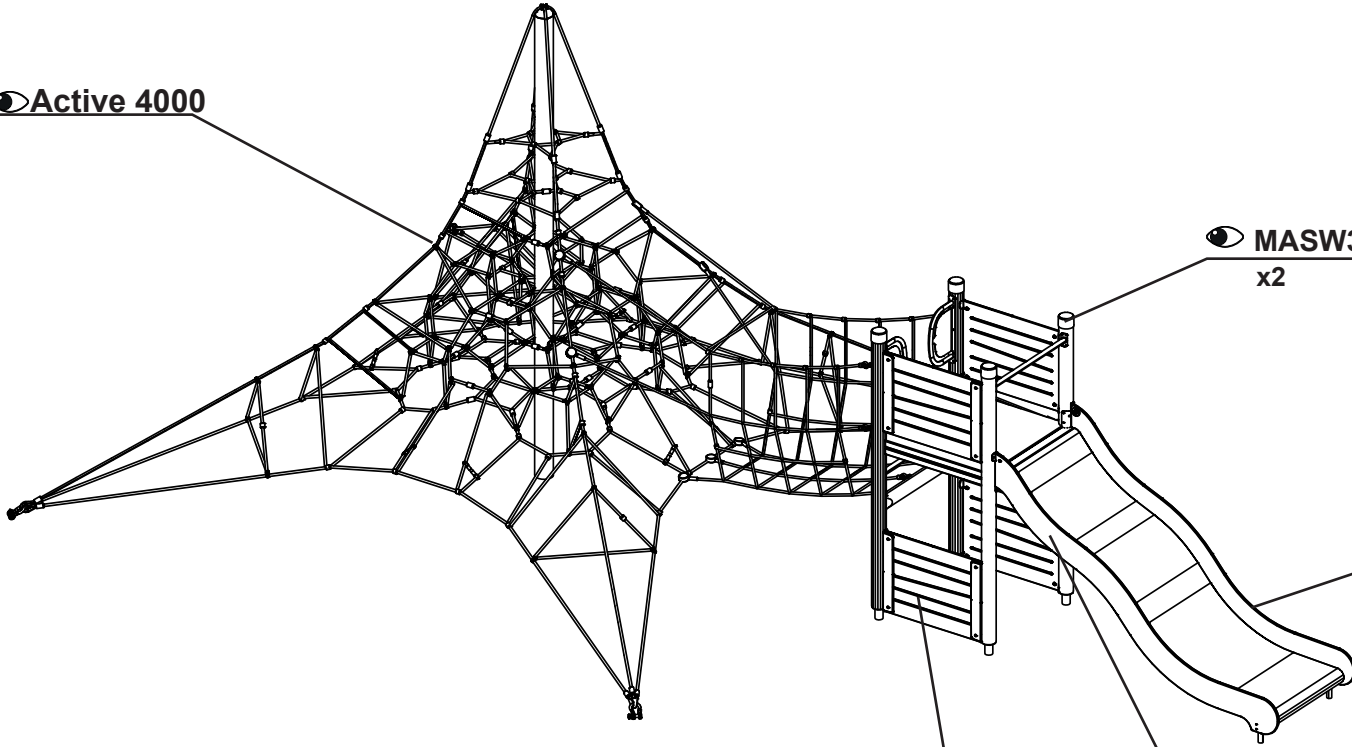

● MASW39775
x2

- MASW67953 [SF]
- MASW67949 [OM]
- MASW67954 [BM]



● MASW104949